

Argentina

PART NUMBER	RATING	SIZE & COND.	COLOR CODE	LENGTH Ft/Mtrs.	NOM. O.D. mm	STD. PKG.	PKG. WT. kg
8960-25M-BB	10A-250V	1.0mm ² x3C	CEE	8.2/2.5	7.1	50	12.720

Standard bulk packaged

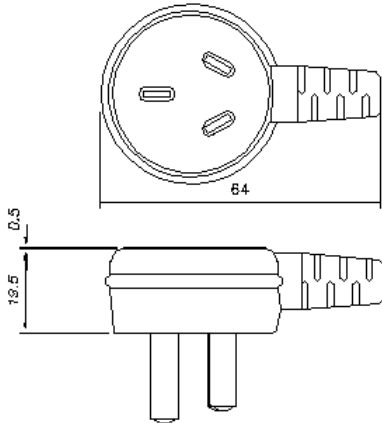

Molded PVC Grounding Plug
IRAM 2073 UC-896

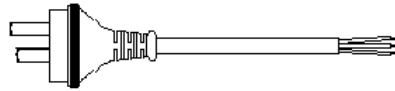

Remove Outer Jacket 50mm Strip, and Twist & Tin 12mm

TYPE H05VV-F



PVC Jacketed, 70°C

PART NUMBER	RATING	SIZE & COND.	COLOR CODE	LENGTH Ft/Mtrs.	NOM. O.D. mm	STD. PKG.	PKG. WT. kg
8965-25M-BB	10A-250V	1.0mm ² x3C	CEE	8.2/2.5	7.1	50	14.080

Standard tied loop hank

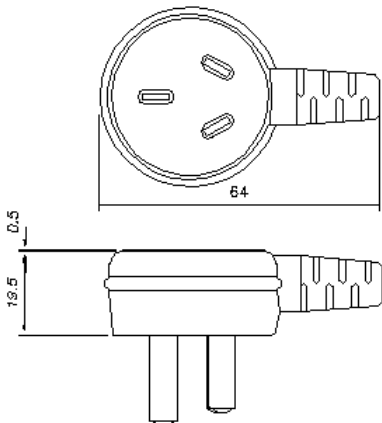

Molded PVC Grounding Plug
IRAM 2073 UC-896

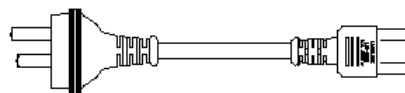

Molded PVC Receptacle
IEC 60320/C13 UC-05I

TYPE H05VV-F



PVC Jacketed, 70°C

Australia and New Zealand

PART NUMBER	RATING	SIZE & COND.	COLOR CODE	LENGTH Ft/Mtrs.	NOM. O.D. mm	STD. PKG.	PKG. WT. kg
8200-25M-BB	10A-250V	1.0mm ² x3C	CEE	8.2/2.5	7.1	50	12.720

Standard bulk packaged



Molded Grounding Plug
AS 3112 UC-822



Remove Outer Jacket 50mm
Strip and Twist 12mm

TYPE SAA



Ordinary Duty, PVC Jacketed, 75°C

PART NUMBER	RATING	SIZE & COND.	COLOR CODE	LENGTH Ft/Mtrs.	NOM. O.D. mm	STD. PKG.	PKG. WT. kg
8250-25M-BB	10A-250V	1.0mm ² x3C	CEE	8.2/2.5	7.1	50	13.620
8250-25M-GG	10A-250V	1.0mm ² x3C	CEE	8.2/2.5	7.1	50	13.620

Standard bulk packaged



Molded Grounding Plug
AS3112 UC-822



Molded PVC Receptacle
IEC 60320/C13 UC-051

TYPE SAA



Ordinary Duty, PVC Jacketed, 75°C

PART NUMBER	RATING	SIZE & COND.	COLOR CODE	LENGTH Ft/Mtrs.	NOM. O.D. mm	STD. PKG.	PKG. WT. kg
8220-25M-BB	7.5A-250V	.75mm ² x2C	CEE	8.2/2.5	1.3/6.6	100	14.530

Standard bulk packaged



Molded Plug
AS3112 UC-821



Removed Outer Jacket 50mm
Strip and Twist 12mm

TYPE SAA



Light Duty, PVC Jacketed, 75°C

Continental Europe

PART NUMBER	RATING	SIZE & COND.	COLOR CODE	LENGTH Ft/Mtrs.	NOM. O.D. mm	STD. PKG.	PKG. WT. kg
8100-25M-BB	10A-250V	1.0mm ² x3C	CEE	8.2/2.5	7.1	50	11.810
8100-25M-GG	10A-250V	1.0mm ² x3C	CEE	8.2/2.5	7.1	50	11.810

Standard bulk packaged



Molded PVC
Grounding Plug
CEE 7/7 UC-813

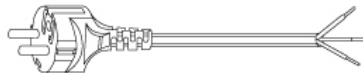

Remove Outer Jacket 50mm
Strip and Tin 12mm

TYPE H05VV-F



PVC Jacketed, 70°C

PART NUMBER	RATING	SIZE & COND.	COLOR CODE	LENGTH Ft/Mtrs.	NOM. O.D. mm	STD. PKG.	PKG. WT. kg
8110-25M-BB	10A-250V	1.0mm ² x3C	CEE	8.2/2.5	7.1	50	12.720

Standard bulk packaged



Molded PVC
Grounding Plug
CEE 7/7 UC-814



Remove Outer Jacket 50mm
Strip and Tin 12mm

TYPE H05VV-F



PVC Jacketed, 70°C

PART NUMBER	RATING	SIZE & COND.	COLOR CODE	LENGTH Ft/Mtrs.	NOM. O.D. Inches	STD. PKG.	PKG. WT. kg
8120-25M-BB	2.5A-250V	.75mm ² x2C	CEE	8.2/2.5	3.4/5.6	100	11.350

Standard bulk packaged



Molded PVC
Plug
CEE 7/16 UC-811



Remove Outer Jacket 50mm
Strip and Tin 12mm

TYPE H05VVH2-F



PVC Jacketed, 70°C

Continental Europe

PART NUMBER	RATING	SIZE & COND.	COLOR CODE	LENGTH Ft/Mtrs.	NOM. O.D. mm	STD. PKG.	PKG. WT. kg
8150-25M-BB	10A-250V	1.0mm ² x3C	CEE	8.2/2.5	7.1	50	14.080
8150-25M-GG	10A-250V	1.0mm ² x3C	CEE	8.2/2.5	7.1	50	14.080

Standard tied loop hank



Molded PVC
Grounding Plug
CEE 7/7 UC-813



Molded PVC
Receptacle
IEC 60320/C13 UC-051I

TYPE H05VV-F



PVC Jacketed, 70°C

PART NUMBER	RATING	SIZE & COND.	COLOR CODE	LENGTH Ft/Mtrs.	NOM. O.D. mm	STD. PKG.	PKG. WT. kg
8192-25M-BB	10A-250V	1.0mm ² x3C	CEE	8.2/2.5	7.1	50	14.530
8192-25M-GG	10A-250V	1.0mm ² x3C	CEE	8.2/2.5	7.1	50	14.530

Standard tied loop hank



Molded PVC
Grounding Plug
CEE 7/7 UC-814



Molded PVC
Receptacle
IEC 60320/C13 UC-051

TYPE H05VV-F



PVC Jacketed, 70°C

Italy

PART NUMBER	RATING	SIZE & COND.	COLOR CODE	LENGTH Ft/Mtrs.	NOM. O.D. mm	STD. PKG.	PKG. WT. kg
8600-25M-BB	10A-250V	1.0mm ² x3C	CEE	8.2/2.5	7.1	50	11.350

Standard bulk packaged

Molded PVC
Grounding Plug
CEI 23-16/VII UC-861

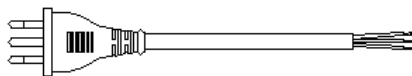

Remove Outer Jacket 50mm
Strip, and Twist & Tin 12mm

TYPE H05VV-F



PVC Jacketed, 70°C

PART NUMBER	RATING	SIZE & COND.	COLOR CODE	LENGTH Ft/Mtrs.	NOM. O.D. mm	STD. PKG.	PKG. WT. kg
8650-25M-BB	10A-250V	1.0mm ² x3C	CEE	8.2/2.5	7.1	50	12.720

Standard tied loop hank

Molded PVC
Grounding Plug
CEI 23-16/VII UC-861

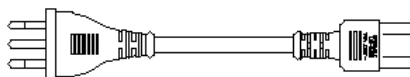

Molded PVC
Receptacle
IEC 60320/C13 UC-051

TYPE H05VV-F



PVC Jacketed, 70°C

Denmark

PART NUMBER	RATING	SIZE & COND.	COLOR CODE	LENGTH Ft/Mtrs.	NOM. O.D. mm	STD. PKG.	PKG. WT. kg
8800-25M-BB	10A-250V	1.0mm ² x3C	CEE	8.2/2.5	7.1	50	12.720

Standard bulk packaged

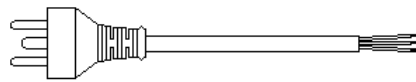
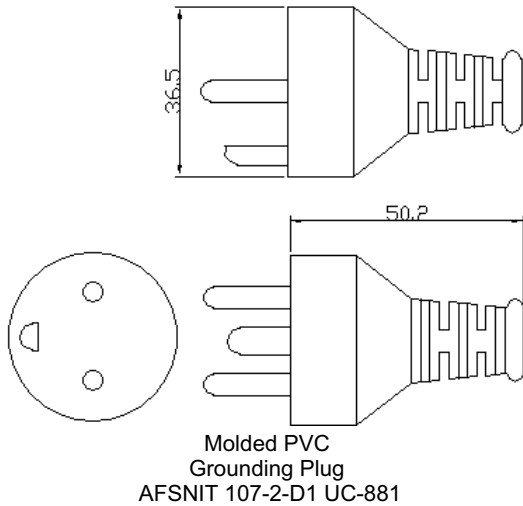

Remove Outer Jacket 50mm Strip, and Twist & Tin 12mm

TYPE H05VV-F



PVC Jacketed, 70°C

PART NUMBER	RATING	SIZE & COND.	COLOR CODE	LENGTH Ft/Mtrs.	NOM. O.D. mm	STD. PKG.	PKG. WT. kg
8801-25M-BB	10A-250V	1.0mm ² x3C	CEE	8.2/2.5	7.1	50	13.620

Standard bulk packaged

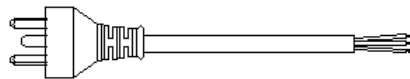
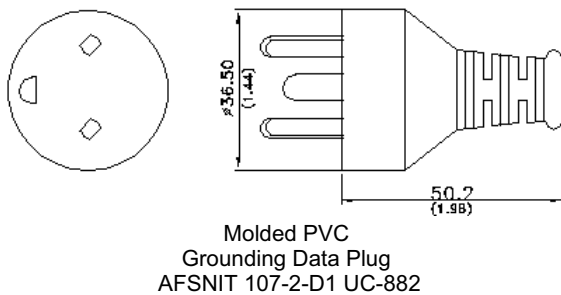

Remove Outer Jacket 50mm Strip, and Twist & Tin 12mm

TYPE H05VV-F





PVC Jacketed, 70°C

PART NUMBER	RATING	SIZE & COND.	COLOR CODE	LENGTH Ft/Mtrs.	NOM. O.D. mm	STD. PKG.	PKG. WT. kg
8850-25M-BB	10A-250V	1.0mm ² x3C	CEE	8.2/2.5	7.1	50	14.990

Standard tied loop hank

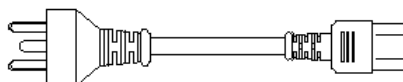
Molded PVC
Grounding Data Plug
AFSNIT 107-2-D1 UC-882

Molded PVC
Receptacle
IEC 60320/C13 UC-051

TYPE H05VV-F



PVC Jacketed, 70°C

Israel

PART NUMBER	RATING	SIZE & COND.	COLOR CODE	LENGTH Ft/Mtrs.	NOM. O.D. mm	STD. PKG.	PKG. WT. kg
8900-25M-BB	10A-250V	1.0mm ² x3C	CEE	8.2/2.5	7.1	50	12.720

Standard bulk packaged

Molded PVC
Grounding Plug
SI 32 UC-891

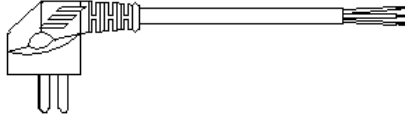

Remove Outer Jacket 50mm
Strip, and Twist & Tin 12mm

TYPE H05VV-F

PVC Jacketed, 70°C

PART NUMBER	RATING	SIZE & COND.	COLOR CODE	LENGTH Ft/Mtrs.	NOM. O.D. mm	STD. PKG.	PKG. WT. kg
8950-25M-BB	10A-250V	1.0mm ² x3C	CEE	8.2/2.5	7.1	50	14.080

Standard tied loop hank

Molded PVC
Grounding Plug
SI 32 UC-891

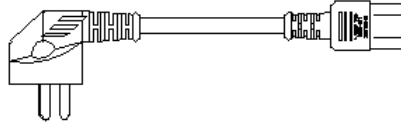

Molded PVC
Receptacle
IEC 60320/C13 UC-051

TYPE H05VV-F

PVC Jacketed, 70°C

Switzerland

PART NUMBER	RATING	SIZE & COND.	COLOR CODE	LENGTH Ft/Mtrs.	NOM. O.D. mm	STD. PKG.	PKG. WT. kg
8400-25M-BB	10A-250V	1.0mm ² x3C	CEE	8.2/2.5	7.1	50	12.260

Standard bulk packaged

Molded PVC
Grounding Plug
SEV 1011 UC-841



Remove Outer Jacket 50mm
Strip, and Twist & Tin 12mm

TYPE H05VV-F



PVC Jacketed, 70°C

PART NUMBER	RATING	SIZE & COND.	COLOR CODE	LENGTH Ft/Mtrs.	NOM. O.D. mm	STD. PKG.	PKG. WT. kg
8450-25M-BB	10A-250V	1.0mm ² x3C	CEE	8.2/2.5	7.1	50	13.620

Standard bulk packaged

Molded PVC
Grounding Plug
SEV 1011 UC-841



Molded PVC
Receptacle
IEC 60320/C13 UC-051

TYPE H05VV-F



PVC Jacketed, 70°C

Japan

PART NUMBER	RATING	SIZE & COND.	COLOR CODE	LENGTH Ft/Mtrs.	NOM. O.D. mm	STD. PKG.	PKG. WT. kg
8300-25M-BB	15A-125V	2.0mm ² x2C	NA	8.2/2.5	8.5	50	25.880
8301-25M-BB	7A-125V	.75mm ² x2C	NA	8.2/2.5	7.0	100	19.070

Standard bulk packaged



Molded PVC
Grounding Plug
JIS 8303 UC-832



Removed Outer Jacket 50mm
Strip and Twist 12mm

TYPE VCTF



PVC Jacketed, 60°C

PART NUMBER	RATING	SIZE & COND.	COLOR CODE	LENGTH Ft/Mtrs.	NOM. O.D. mm	STD. PKG.	PKG. WT. lbs.
8350-25M-BB	15A-125V	2.0mm ² x2C	NA	8.2/2.5	8.5	50	25.880
8351-25M-BB	7A-125V	.75mm ² x2C	NA	8.2/2.5	7.0	100	19.070

Standard bulk packaged



Molded PVC
Grounding Plug
JIS 8303 UC-832



Molded PVC
Receptacle
IEC 60320/C13 UC-837

TYPE VCTF



PVC Jacketed, 60°C

PART NUMBER	RATING	SIZE & COND.	COLOR CODE	LENGTH Ft/Mtrs.	NOM. O.D. mm	STD. PKG.	PKG. WT. kg
8320-25M-BB	7A-125V	.75mm ² x2C	NA	8.2/2.5	4.3/6.6	150	20.430

Standard bulk packaged



Molded PVC
Grounding Plug
JIS 8308 UC-830



Removed Outer Jacket 50mm
Strip and Twist 12mm

TYPE HVCTFK



PVC Jacketed, 75°C

UK (Great Britain)

PART NUMBER	RATING	SIZE & COND.	COLOR CODE	LENGTH Ft/Mtrs.	NOM. O.D. mm	STD. PKG.	PKG. WT. kg
8500-25M-BB	10A-250V	1.0mm ² x3C	CEE	8.2/2.5	6.9	50	15.440
8501-25M-BB	13A-250V	1.5mm ² x3C	CEE	8.2/2.5	8.94	50	17.710

Standard bulk packaged

Molded PVC
Grounding Plug
BS 1363 Fused UC-851



Remove Outer Jacket 50mm
Strip and Twist 12mm

TYPE H05VV-F



PVC Jacketed, 70°C, Harmonized

PART NUMBER	RATING	SIZE & COND.	COLOR CODE	LENGTH Ft/Mtrs.	NOM. O.D. mm	STD. PKG.	PKG. WT. kg
8550-25M-BB	10A-250V	1.0mm ² x3C	CEE	8.2/2.5	6.9	50	16.350 (w/ 10A Fuse)

Standard bulk packaged

Molded PVC
Grounding Plug
BS 1363 Fused UC-851



Molded PVC
Receptacle
IEC 60320/C13 UC-852

TYPE H05VV-F



PVC Jacketed, 70°C, Harmonized

South Africa

PART NUMBER	RATING	SIZE & COND.	COLOR CODE	LENGTH Ft/Mtrs.	NOM. O.D. mm	STD. PKG.	PKG. WT. kg
8700-25M-BB	10A-250V	1.0mm ² x3C	CEE	8.2/2.5	7.1	50	15.440

Standard bulk packaged

Molded PVC
Grounding Plug
SABS164/1980 UC-871

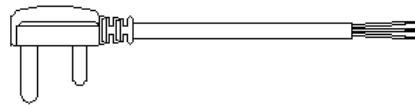

Remove Outer Jacket 50mm
Strip, and Twist & Tin 12mm

TYPE H05VV-F

PVC Jacketed, 70°C

PART NUMBER	RATING	SIZE & COND.	COLOR CODE	LENGTH Ft/Mtrs.	NOM. O.D. mm	STD. PKG.	PKG. WT. kg
8750-25M-BB	10A-250V	1.0mm ² x3C	CEE	8.2/2.5	7.1	50	17.710

Standard tied loop hank

Molded PVC
Grounding Plug
SABS164/1980 UC-871

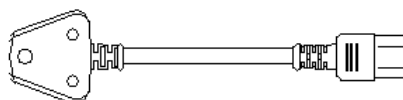

Molded PVC
Receptacle
IEC 60320/C13 UC-051

TYPE H05VV-F

PVC Jacketed, 70°C