

ANSI C73.80

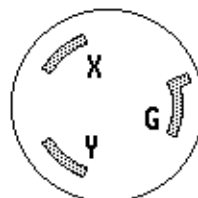

Cord Clamp Range
Plug & Connector
9.8 - 21.8 mm

**NEMA
L8-30P**

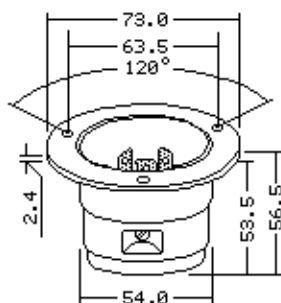
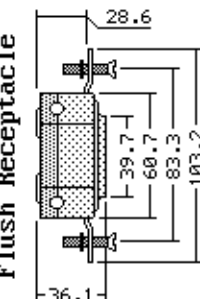

UL CSA

Dimensions
= mm

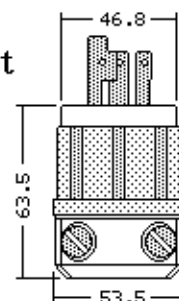
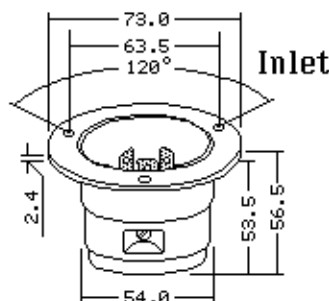

**LOCKING
INDUSTRIAL**

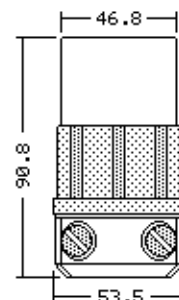
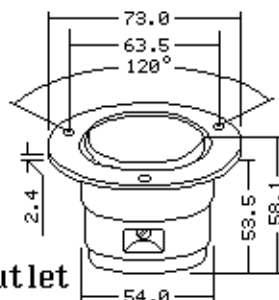

480V AC-30A, 2-Pole 3-Wire Ground

Catalog Number	Beschreibung	Description	NEMA	UPE/Pack
2641■	Stecker	Plug	L 8-30P	30
2643■	Kupplung	Connector	L 8-30R	30
2646■	Einbausteckdose	Flanged Outlet	L 8-30R	10
2645■	Einbaustecker	Flanged Inlet	L 8-30P	10
2640■	Steckdose	Flush Receptacle	L 8-30R	30
2640-IG	-isolierte Erde	-Insulated Ground	L 8-30R	30