

METAL HALIDE LAMPS

Arcstream™	3-14
ChromaFit™ Multi-Vapor®	3-13
ConstantColor® CMH™	3-9
High Output Multi-Vapor®	3-12
I-Line Multi-Vapor®	3-14
Multi-Vapor®	3-10
Protected High Output Multi-Vapor®	3-13
PulseArc™ Multi-Vapor®	3-9
Saf-T-Gard® Multi-Vapor®	3-14

HIGH PRESSURE SODIUM LAMPS

Deluxe Lucalox®	3-17
Ecolux® NC Non-Cycling	3-17
E-Z Lux®	3-17
Lucalox®	3-15

LOW PRESSURE SODIUM LAMPS

SOX Low Pressure Sodium	3-17
-------------------------------	------

MERCURY LAMPS

E-Z Merc® Self-ballasted	3-19
Saf-T-Gard® Mercury	3-19
Standard Mercury	3-18

EXPORT LAMPS

Export Lamps	3-20
--------------------	------

To learn more about B-I-A please visit us at our
WEB site: www.BiaGmbH.com



BULB IDENTIFICATION

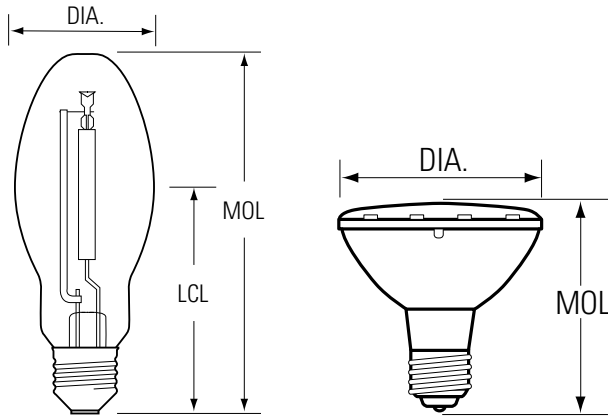

DIA: Diameter of bulb at widest point.

MOL: Maximum Overall Length including base or pins.

LCL: Distance between the center of the arc tube and the Light Center Length reference plane.

Note: Lamp drawings are not drawn to scale.

Be sure to check size and dimension information when identifying each lamp.

To convert inches to millimeters, multiply the dimension (in inches) by 25.4 (i.e. 1.5" x 25.4 = 38.1 mm).

LAMP LOCATOR

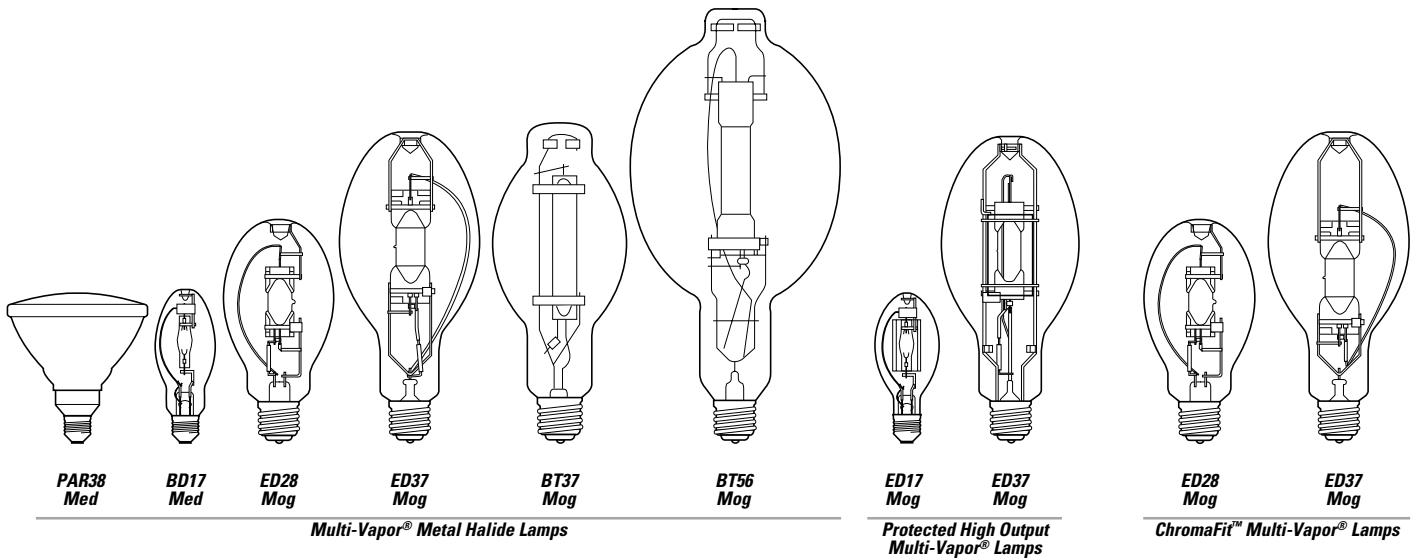
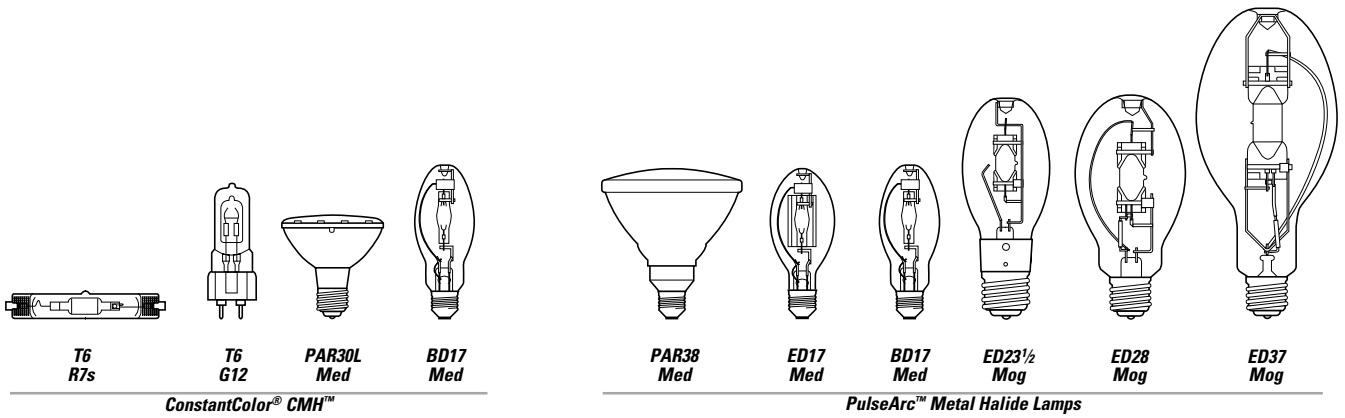

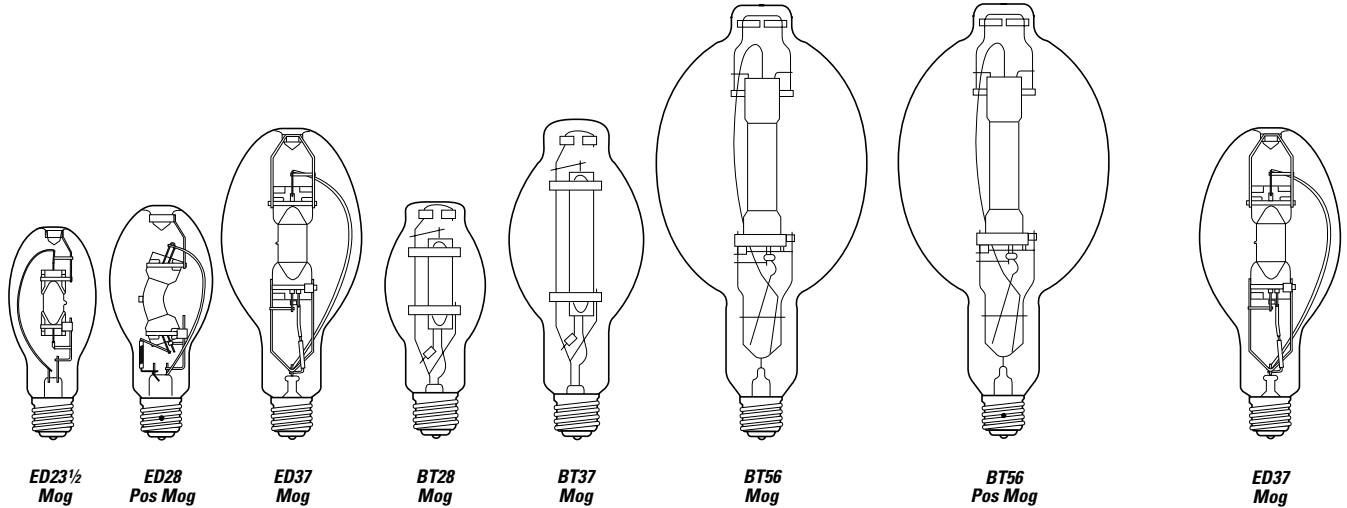

High Output Multi-Vapor® Metal Halide Lamps

Saf-T-Gard® Self-Extinguishing Multi-Vapor Lamps

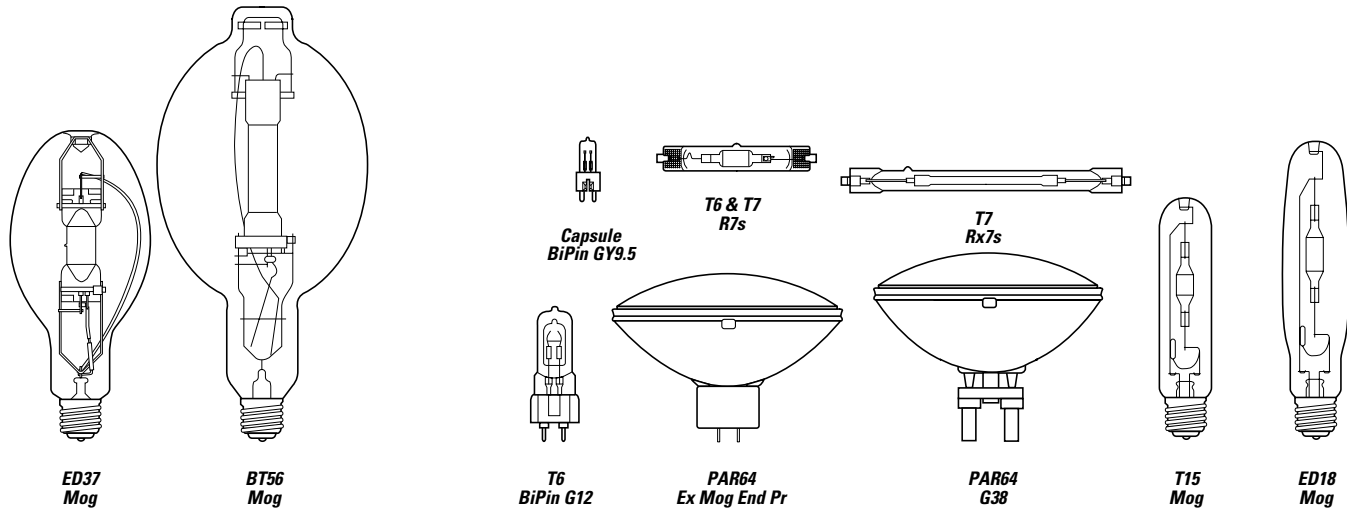

I-Line Multi-Vapor® Lamps

Arcstream™ Metal Halide Lamps

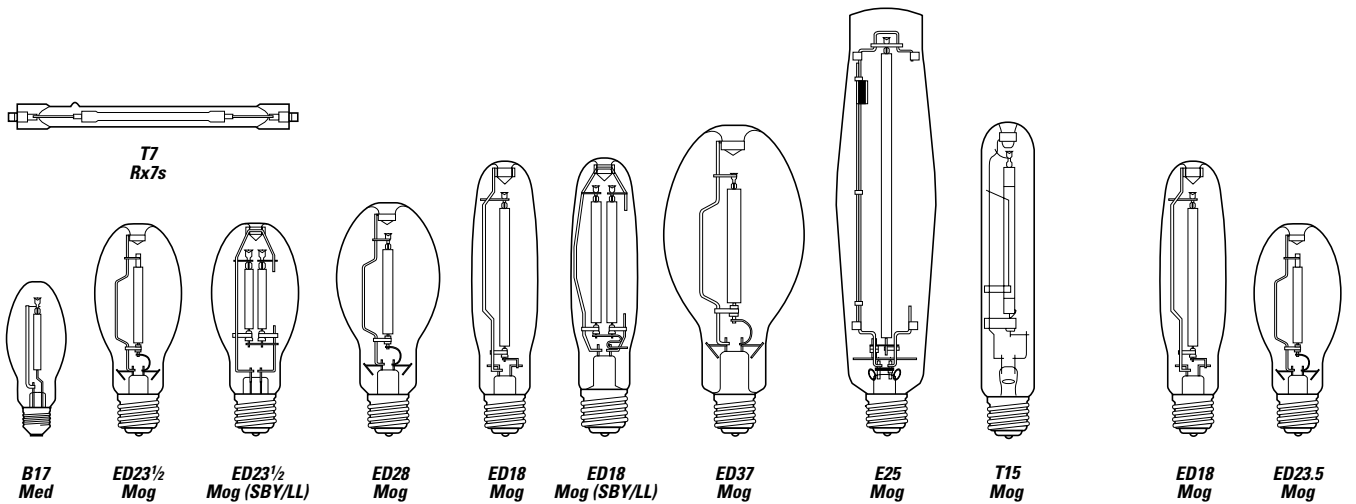

Lucalox® High Pressure Sodium Lamps

Ecolux® NC Non-Cycling High Pressure Sodium Lamps

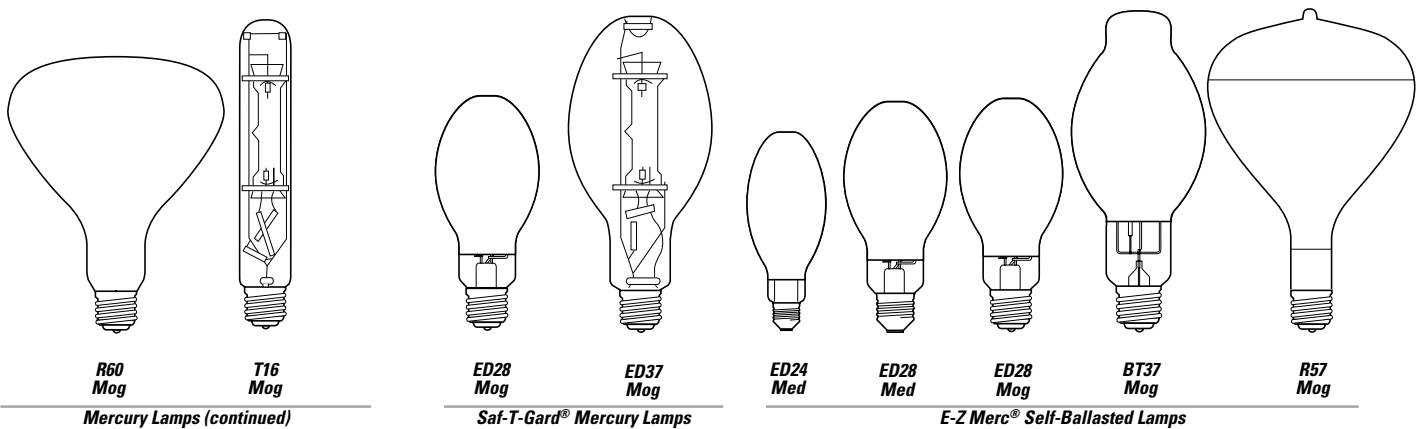
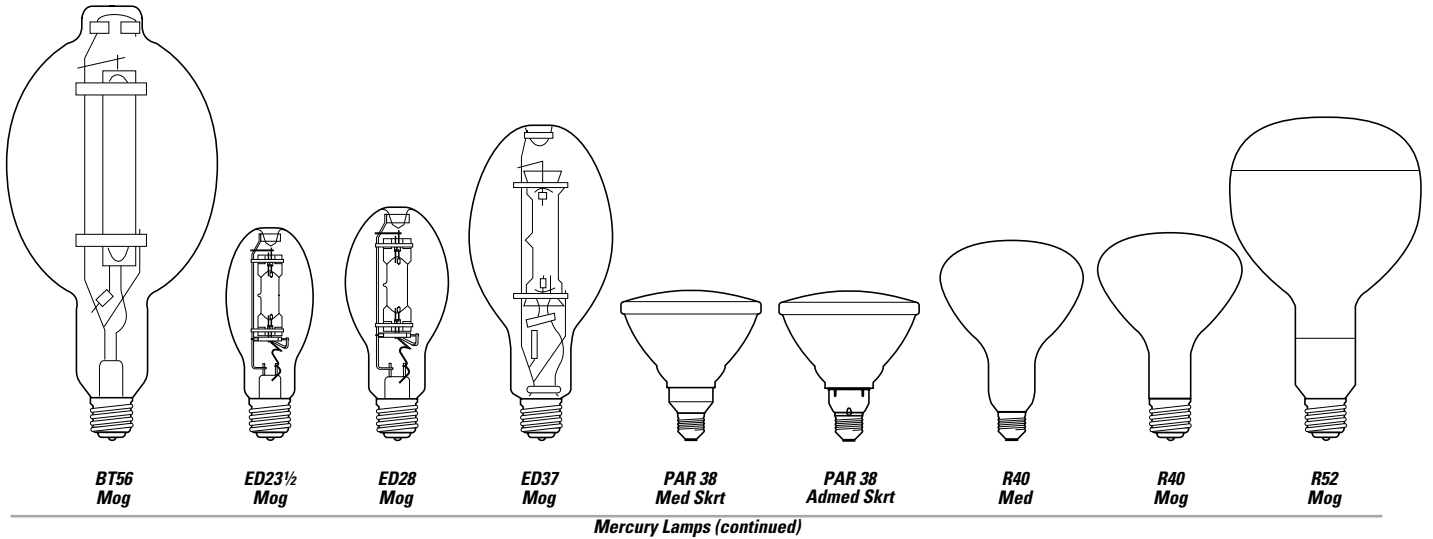
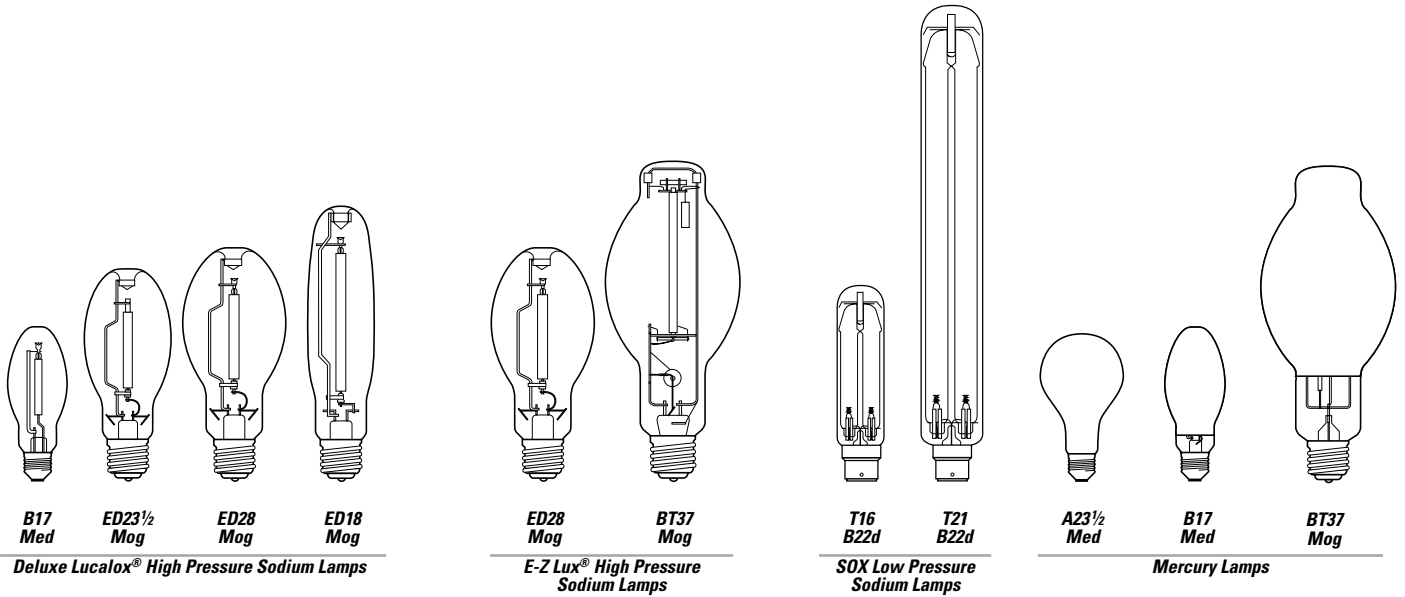

BASE IDENTIFICATION



Med Screw
E26



Export
E27

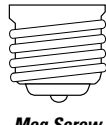

Mog Screw
E39

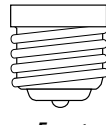

Export
E40



Position-
Oriented Mogul

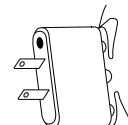

Ext. Mog End Pr
GX16d

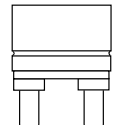

Mogul BiPost
G38

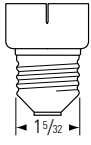

Admedium Skirted

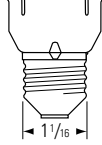

Med Skirt
E26/50x39

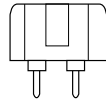

BiPin
G12



PG12
(Export Only)



Recessed
Single Contact
R7s



2-Lug Sleeve
B22d

INTRODUCTION

HID lamps provide the following benefits:

High Efficacy/Low Operating Cost.

HID is generally the most efficient light source. Better efficiency almost always means lower operating cost.

Long Life.

Most HID lamps have life ratings that are better than incandescent lamps and similar to fluorescent lamps.

Compact Size.

An HID lamp produces high light output from a relatively compact source. Like incandescent, it is a "point" light source, which allows for good optical control.

The chart below shows how HID lamps compare to incandescent, halogen, and fluorescent in terms of efficiency and rated average life. Efficiency is measured in lumens per watt (LPW). Rated average life for most lamp types is the number of burning hours when 50% of the tested samples have failed and 50% are still operational. For both HID and fluorescent, lamp life depends on the number of hours per start.

The combination of high efficiency and long life makes HID an ideal light source for many commercial and industrial applications.

Typical Lamp Characteristics

Lamp Type	Typical LPW	Rated Avg. Life (in hours)
Incandescent	5 - 22	750 - 2000
Halogen	12 - 36	2000 - 6000
Compact Fluorescent	27 - 80	9000 - 20,000
Fluorescent	75 - 100	12,000 - 24,000 +
Mercury	50 - 60	12,000 - 24,000 +
ConstantColor® CMH™	80 - 90	6,000 - 10,000
Multi-Vapor® Metal Halide	80 - 115	10,000 - 20,000
Lucalox® High Pressure Sodium	90 - 140	10,000 - 40,000

SUGGESTED COLOR APPLICATIONS FOR HID LAMPS

CMH™: Stores, people places, display, accent.

MVR: Stores, public spaces, industrial, gymnasiums, floodlighting signs and buildings, parking areas, sports.

MVR/C: Same as MVR – warmer color – diffuse coating reduces glare.

MVR/SP30: Same as MVR – warmer than MVR or MVR/C – matches SP30 fluorescent.

MXR: Warm color (3200K) – good match for halogen.

LU: Street lighting, parking areas, industrial, floodlighting, security, CCTV.

LU/DX: Floodlighting, parking areas, indoor/outdoor pedestrian malls, industrial, security, roadway.

Deluxe (DX) Mercury: Stores, public spaces – Metal Halide lamps however, are preferred.

Clear Mercury: Landscape lighting, specialized floodlighting such as green copper roofs.

PRODUCT INFORMATION

CONSTANTCOLOR® CMH™ CERAMIC METAL HALIDE LAMPS (pg 3-9)

- Color uniformity lamp-to-lamp and over lamp life
- Excellent color rendering (85+CRI)
- Delivers more light than standard metal halide (10%–20% more than standard metal halide)
- Lamp operates at high efficacy — up to 95 lumens per watt
- Universal burn — may be operated in any position
- Easy retrofit since lamp operates on standard metal halide ballasts
- Perfect for retail and commercial display lighting, accent and floodlighting, lobby and foyer lighting. Ideal for "people places."

PRODUCT INFORMATION (Continued)**PULSEARC™ MEDIUM BASED METAL HALIDE LAMPS (/MED MODELS) (pg 3-9 and 3-10)**

- Low wattage metal halide lamps (formerly Halarc®) are now part of the PulseArc™ family
- Compact source
- Sparkling white light (3000-4000K) and very good color rendition (70-75CRI)
- High efficacy – more than 3 times the lumens per watt of incandescent
- Long life – up to 15 times longer than incandescent systems and up to 7 times longer than most PAR and R systems, saving maintenance and labor costs
- Superior optical control
- Uses: Display lighting, downlighting, floodlighting, corridors, lobbies, walkways; retail, office, commercial

PULSEARC™ MULTI-VAPOR® METAL HALIDE LAMPS (/PA MODELS) (pg 3-10)

- Designed for operation only on approved ballasts with metal halide pulse ignitors
- More light – 400W lamps provide highest initial and highest maintained lumens versus other standard universal or vertical base-up lamp options
- 50% longer life – 400W lamps provide 30,000 hours life when burned on 120 hour on/1 hour off cycle (approximately continuous)
- Faster hot restrike – less than 4 minutes versus 10-15 minutes for typical metal halide lamps

MULTI-VAPOR® METAL HALIDE LAMPS (pg 3-10 and 3-11)

- Sparkling white light (3000-4000K) and very good color rendition (65-75CRI)
- Warm, rich 3000K color of SP30 blends well with incandescent, halogen and triphosphor fluorescent lamps for interior retail applications
- High efficacy – more efficient than incandescent, mercury and most fluorescent sources
- Long life – 10,000-20,000 hours for most types
- Full line, 150-1000 watts, to meet most application needs
- Uses: Downlighting, floodlighting, corridors, lobbies, walkways; retail, commercial, industrial

HIGH OUTPUT MULTI-VAPOR® LAMPS (pg 3-12 and 3-13)

- More light – optimized for higher light output in horizontal, vertical base-up and base-down burn applications
 - Horizontal burn lamps provide up to 25% more light than standard universal burn equivalents
 - Vertical burn lamps provide up to 11% more light than standard universal burn equivalents
 - 400W/XHO (formerly /XL) vertical burn lamps provide up to 17% more light than standard universal burn equivalents; the highest lumen lamps available for operation on standard M59 ballasts
- Longer life – horizontal burn lamps last up to 67% longer than universal burn lamp equivalents, significantly reducing replacement lamp and maintenance costs
- Brighter longer - introducing Staybright™ (/STB) with 30% higher mean lumens
- Uses: any application where fixed-orientation lamps can be used. Gas stations, sports lighting, billboards, retail, office, roadway, parking garages, floodlights, sign lighting.

PROTECTED HIGH OUTPUT MULTI-VAPOR® LAMPS (/O) (pg 3-13)

- Protective quartz jacket surrounds the arc tube
- The /O suffix in the Lamp Description indicates lamps are suitable for open fixture applications

CHROMAFIT™ MULTI-VAPOR® LAMPS (/R) (pg 3-13)

- Convert high pressure sodium sockets to crisp white metal halide light
- Operate on standard HPS ballasts and auxiliary equipment
- Uses: Area lighting, industrial and “people places”

I-LINE MULTI-VAPOR® LAMPS (pg 3-14)

- Convert mercury sockets to crisp, white metal halide light
- More light, better color, energy cost savings for mercury users
- 40%-100% more light than existing mercury lamps
- Operate on standard CW and CWA mercury ballasts and auxiliary equipment

SAF-T-GARD® MULTI-VAPOR LAMPS (MVT) (pg 3-14)

- Special self-extinguishing feature prevents exposure to harmful UV in case outer bulb is punctured or broken; lamp turns off within 15 minutes
- Certified to meet Federal Standard 21CFR1040.30
- Saf-T-Gard® I-line lamps convert mercury sockets to crisp, white metal halide light
- Saf-T-Gard® I-line lamps operate on standard mercury ballasts and auxiliary equipment
- Uses: Industrial, commercial, gymnasiums, sports complexes, especially where open fixtures are used and risk of outer bulb breakage is possible

ARCSTREAM™ METAL HALIDE LAMPS (pg 3-14 and 3-15)

- Compact size, white light, excellent color
- Precise optical control delivers a concentrated beam of light right where it's needed
- Variety of color temperatures (3,000K - 6,000K)
- PAR64: ideal for long-range projection and sports lighting applications
- Uses: Ideal for retail and commercial display lighting, floodlighting, accent/highlighting

LUCALOX® HIGH PRESSURE SODIUM LAMPS (pg 3-15 and 3-16)

- Very high efficacy/low operating cost
- Superior lumen maintenance – over 90% @ 50% of life
- Very long life – 24,000+ hours
- Universal burn – can be operated in any position without affecting performance
- Warm color
- For open or enclosed fixtures
- Uses: Industrial, roadway, security, floodlighting

PRODUCT INFORMATION (Continued)**STANDBY LONGLIFE LUCALOX® LAMPS (/SBY) (pg 3-15 and 3-16)**

- Extra arc tube provides light instantly after momentary power interruption, and will increase to 80% light output in 1-2 minutes
- Dual arc tubes provide 40,000 hour rated life
- Operates on standard HPS ballasts and auxiliary equipment
- Uses: Industrial, roadway, security, and hard-to-reach sockets

ECOLUX® NC "NON-CYCLING" HIGH PRESSURE SODIUM LAMPS (/ECO/NC) (pg 3-17)

- Low mercury. Passes TCLP, which can lower disposal costs.
- Non-cycling feature makes locating and replacing end-of-life lamps quick and easy
- Lead-free base
- High efficacy/low operating cost
- 6%-11% higher initial lumens than standard HPS in 100W and 400W versions
- Long life - 24,000 hours
- Open or enclosed fixtures
- Uses: Industrial, roadway, security

DELUXE LUCALOX® HIGH PRESSURE SODIUM LAMPS (pg 3-17)

- High efficacy, lumen maintenance and long life of standard Lucalox® HPS
- High color rendering (65-70CRI), much better than standard HPS
- Blends well with incandescent and standard HPS sources
- Operates on standard HPS ballasts and auxiliary equipment
- Uses: Storage rooms, industrial facilities, offices, gymnasiums, malls, parks, building floodlighting

DOUBLE-ENDED LUCALOX® LAMPS (/TD) (pg 3-16)

- Compact tubular design fits compact fixtures for excellent optical control
- High efficacy, lumen maintenance and long life of standard Lucalox® HPS

E-Z LUX® HIGH PRESSURE SODIUM LAMPS (pg 3-17)

- Direct replacement for mercury lamps on mercury ballasts
- More efficient, 57-114% more lumens and 10-14% fewer watts than mercury lamps they replace
- Uses: General lighting, roadway
- See operating notes for further information

SOX LOW PRESSURE SODIUM LAMPS (pg 3-17 and 3-18)

- Highest luminous efficacy for general, not for color-critical lighting
- Monochromatic, yellow color (589nm)

MERCURY LAMPS (pg 3-18 and 3-19)

- Long life and good efficacy
- Phosphor coated Deluxe lamps provide good color rendering (50CRI)
- Uses: Industrial, roadway, landscapes, residential and commercial security, parking lots

SAF-T-GARD® MERCURY LAMPS (pg 3-19)

- Special self-extinguishing feature prevents exposure to harmful UV in case outer bulb is punctured or broken; lamp turns off within 15 minutes
- Certified to meet Federal Standard 21 CFR 1040.30
- See operating notes for further information

EZ MERC® SELF BALLASTED MERCURY LAMPS (pg 3-19)

- Retrofit incandescent sockets to longer-life mercury lamps without additional mercury ballasts or auxiliary equipment

EXPORT BASE LAMPS (pg 3-20)

- Export-only lamps are not intended for use in North America due to potential shock hazard. The lamps are identified by "/27" or "/40" at the end of the lamp description, and comply with electrical characteristics defined by IEC standards.
- Bulb shapes are generally similar to U.S. lamp types. Refer to drawings on [pages 3-2 to 3-4](#).

HEADINGS IN THIS CATALOG SECTION

The following terms and descriptions can help you when checking High Intensity Discharge lamp specifications and when ordering products. Within each product line, lamps are divided into families. Within families, lamps are listed by wattage. In each of these wattage groups, lamps are listed by bulb shape.

Bulb:

Bulb shape followed by its size (the maximum diameter of the bulb expressed in eighths of an inch).

Product Code:

It is important to use this five-digit code when ordering to ensure that you receive the exact product you require.

Base:

The type of base.

Lamp Description:

The lamp's identification code.

Case Qty:

Number of product units packed in a case.

Fixture Req:

Describes fixture requirements for this lamp (see page 3-21).

Additional Information:

Typical application and/or other important information including footnotes ()*.

ANSI Ballast Type:

Ballast type used to operate lamp.

Lumens - Initial:

Initial light output.

Lumens - Mean:

Lamp light output (lumens) at 40% of rated lamp life for Metal Halide lamps and 50% of rated life for Mercury and HPS lamps.

Color Temperature Kelvins (K):

A measure of the visual "warmth" or "coolness" of the light from the lamp. The higher the value the whiter or "cooler" the light appears.

MOL:

Maximum Overall Length in inches.

LCL:

Distance between the center of the filament and the Light Center Length reference plane, in inches.

Rated Avg Life - Hrs:

Lamp burning hours to median life expectancy.

Bulb	Base	Product Code	Lamp Description	Case Qty.	Fix. Req.	Additional Information	ANSI Ballast Type	Lumens Initial	Lumens Mean [†]	Rated Avg. Life Hours	MOL in.	LCL in.	Color Temp. K	CRI
HIGH OUTPUT MULTI-VAPOR® METAL HALIDE LAMPS														
400 WATTS														
ED37	Mog	49656	MVR400/C/VBU	6	0	Coated, Vertical Base Up ±15°	M59	41000	25000	20000	11 ⁵ / ₁₆	7	3700	70

MVR400 / C / VBU

Identifies as Multi-Vapor® lamp.

Identifies the lamp's wattage.

Outer bulb finish.

Burning position (see page 3-21)

WHEN YOU DON'T KNOW THE LAMP DESCRIPTION

1. Identify bulb shape by using illustrations on pages 3-2 to 3-4.
2. Measure bulb diameter using ruler in Appendix section page A-1 to determine width in eighths of an inch.
3. Identify base type using table on page 3-5.
4. Find your lamp in the tabular data containing the bulb shape, size and base, which are all listed by wattage.

Bulb	Base	Product Code	Lamp Description	Case Qty.	Fix. Req.	Additional Information	ANSI Ballast Type	Lumens Initial	Lumens Mean†	Rated Avg. Life Hours	MOL in.	LCL in.	Temp. K	Color CRI
CONSTANTCOLOR® CMH™ METAL HALIDE LAMPS														
70 WATTS														
T6	G12	35421	CMH70/T/830/G12	10	E	Clear (31, 33)*	M85 or M98 (Alt)	6200	4750	6000	3 ¹⁵ / ₁₆	2 ³ / ₁₆	3000	85
T6	R7s	34519	CMH70/TD/830/R7S	12	E	Clear, Horizontal ±45° Only (31, 33)*	M85 or M98 (Alt)	6200	4750	10000	4 ⁵ / ₈	2 ¹ / ₄	3000	85
BD17	Med	22119	CMH70/U/830/MED	6	E	Clear	M98	6200	4470	7500	5 ⁷ / ₁₆	3 ³ / ₁₆	3000	85
		22124	CMH70/C/U/830/MED	6	E	Coated	M98	5890	3800	7500	5 ⁷ / ₁₆	3 ³ / ₁₆	3000	85
PAR30L	Med	22152	CMH70/U/PAR30L/15	6	0	Beam Spread 15°, 25,000 CBCP	M98	4100	3140	6000	4 ³ / ₄		3000	85
		22159	CMH70/U/PAR30L/40	6	0	Beam Spread 40°, 7,000 CBCP	M98	4100	3140	6000	4 ³ / ₄		3000	85
150 WATTS														
T6	RX7s	36912	CMH150/TD/830/RX7S	12	E	Clear, UV Control, Horizontal ±45° Only (31, 33, 39)*	M81 or M102 (Alt)	13500	10350	7000	5 ³ / ₈	2 ⁵ / ₈	3000	85
T6	G12	36863	CMH150/T/830/G12	10	E	Clear, UV Control (31, 33, 39)*	M81 or M102 (Alt)	13500	10350	6000	4 ⁵ / ₈	2 ¹ / ₄	3000	85
PULSEARC™ MULTI-VAPOR® METAL HALIDE LAMPS														
32 WATTS														
ED17	Med	12651	MXR32/C/VBD/O	6	0	Coated, Vertical Base Down ±15°	M100	2400	1700	10000	5 ⁷ / ₁₆	3 ⁷ / ₁₆	3200	70
		16469	MXR32/C/VBU/O	6	0	Coated, Vertical Base Up ±15°	M100	2400	1700	10000	5 ⁷ / ₁₆	3 ⁷ / ₁₆	3200	70
MXR32 METAL HALIDE BALLAST														
		18778	HAL32/120	6		Ballast for 120v 60Hz service	M100							
50 WATTS														
BD17	Med	10361	MXR50/U/MED	6	E	Clear	M110	3900	2200	5000	5 ⁷ / ₁₆	3 ⁷ / ₁₆	3200	70
		10364	MXR50/C/U/MED	6	E	Coated	M110	3500	1900	5000	5 ⁷ / ₁₆	3 ⁷ / ₁₆	3200	70
		12581	MVR50/U/MED	6	E	Clear	M110	3100	1900	5000	5 ⁷ / ₁₆	3 ⁷ / ₁₆	4000	75
		12583	MVR50/C/U/MED	6	E	Coated	M110	2900	1600	5000	5 ⁷ / ₁₆	3 ⁷ / ₁₆	4000	75
70 WATTS														
ED17	Med	12377	MXR70/U/MED/O	6	0	Clear	M98	5500	3500	12000	5 ⁷ / ₁₆	3 ⁷ / ₁₆	3200	70
		12577	MXR70/C/U/MED/O	6	0	Coated	M98	5300	3300	12000	5 ⁷ / ₁₆	3 ⁷ / ₁₆	3200	70
BD17	Med	22158	MXR70/U/MED	6	E	Clear	M98	5500	3500	12000	5 ⁷ / ₁₆	3 ⁷ / ₁₆	3200	70
		22162	MXR70/C/U/MED	6	E	Coated	M98	5300	3300	12000	5 ⁷ / ₁₆	3 ⁷ / ₁₆	3200	70
		12590	MVR70/U/MED	6	E	Clear	M98	4700	3000	12000	5 ⁷ / ₁₆	3 ⁷ / ₁₆	4000	75
		12594	MVR70/C/U/MED	6	E	Coated	M98	4500	2800	12000	5 ⁷ / ₁₆	3 ⁷ / ₁₆	4000	75
PAR38	Med	12741	MXR70/U/PAR/SP	12	0	Clear, Spot, Beam Spread 12°, 50,000 CBCP	M98	4000	2740	7500	5 ⁷ / ₁₆		3000	70
		12745	MXR70/U/PAR/FL	12	0	Clear, Flood, Beam Spread 40°, 6,500 CBCP	M98	4000	2740	7500	5 ⁷ / ₁₆		3000	70
		12746	MXR70/U/PAR/WFL	12	0	Clear, Wide Flood, Beam Spread 60°, 3,200 CBCP	M98	4000	2740	7500	5 ⁷ / ₁₆		3000	70

† In actual applications, mean lumens will be higher for Metal Halide lamps operated on CW or CWA ballasts

To save energy costs, find the bulbs with the light output you need, then choose the one with the lowest watts.

() * All footnote references found at the end of this section. ⚡ Reduced Wattage / High Color Rendering. To convert inches to millimeters, multiply by 25.4.

Bulb	Base	Product Code	Lamp Description	Case Qty.	Fix. Req.	Additional Information	ANSI Ballast Type	Lumens Initial	Lumens Mean†	Rated Avg. Life Hours	MOL in.	LCL in.	Color Temp. K	CRI
PULSEARC™ MULTI-VAPOR® METAL HALIDE LAMPS (Continued)														
100 WATTS														
ED17	Med	12381	MXR100/U/MED/O	6	0	Clear	M90	9000	6200	15000	5 ⁷ / ₁₆	3 ⁷ / ₁₆	3200	70
		12579	MXR100/C/U/MED/O	6	0	Coated	M90	8500	5900	15000	5 ⁷ / ₁₆	3 ⁷ / ₁₆	3200	70
BD17	Med	18680	MXR100/U/MED	6	E	Clear	M90	9000	6200	15000	5 ⁷ / ₁₆	3 ⁷ / ₁₆	3200	70
		18679	MXR100/C/U/MED	6	E	Coated	M90	8500	5900	15000	5 ⁷ / ₁₆	3 ⁷ / ₁₆	3200	70
		12652	MVR100/U/MED	6	E	Clear	M90	8100	5800	15000	5 ⁷ / ₁₆	3 ⁷ / ₁₆	4000	75
		12653	MVR100/C/U/MED	6	E	Coated	M90	7600	4900	15000	5 ⁷ / ₁₆	3 ⁷ / ₁₆	4000	75
PAR38	Med	12747	MXR100/U/PAR/SP	12	0	Clear, Spot, Beam Spread 12°, 54,000 CBCP	M90	5500	3400	7500	5 ⁷ / ₁₆		3000	70
		12748	MXR100/U/PAR/FL	12	0	Clear, Flood, Beam Spread 40°, 10,000 CBCP	M90	5500	3400	7500	5 ⁷ / ₁₆		3000	70
		12749	MXR100/U/PAR/WFL	12	0	Clear, Wide Flood, Beam Spread 65°, 4,500 CBCP	M90	5500	3400	7500	5 ⁷ / ₁₆		3000	70
150 WATTS														
BD17	Med	22935	MXR150/U/MED	6	E	Clear	M102	12500	8600	15000	5 ⁷ / ₁₆	3 ⁷ / ₁₆	3200	70
		22936	MXR150/C/U/MED	6	E	Coated	M102	12000	8300	15000	5 ⁷ / ₁₆	3 ⁷ / ₁₆	3200	70
		12598	MVR150/U/MED	6	E	Clear	M102	11700	8100	15000	5 ⁷ / ₁₆	3 ⁷ / ₁₆	4000	75
		12604	MVR150/C/U/MED	6	E	Coated	M102	11200	7700	15000	5 ⁷ / ₁₆	3 ⁷ / ₁₆	4000	75
175 WATTS														
ED23 ¹ / ₂	Mog	22342	MXR175/VBU/PA	6	E	Clear, Vertical Base Up ±15° (34)*		17200	13400	15000	7 ¹ / ₂	5	3200	65
		11185	MXR175/C/VBU/PA	6	E	Coated, Vertical Base Up ±15° (34)*		16250	12500	15000	7 ¹ / ₂	5	3200	65
		12622	MVR175/VBU/PA	6	E	Clear, Vertical Base Up ±15° (34)*		17700	13800	15000	7 ¹ / ₂	5	4000	75
		12633	MVR175/C/VBU/PA	6	E	Coated, Vertical Base Up ±15° (34)*		17700	12000	15000	7 ¹ / ₂	5	4000	75
BD17	Med	12636	MVR175/VBU/MED/PA	6	E	Clear, Vertical Base Up ±15° (34)*		17700	13800	15000	5 ³ / ₄	3 ⁷ / ₁₆	4000	75
		12637	MVR175/C/VBU/MED/PA	6	E	Coated, Vertical Base Up ±15° (34)*		16400	12000	15000	5 ³ / ₄	3 ⁷ / ₁₆	4000	75
250 WATTS														
ED28	Mog	26317	MVR250/VBU/PA	12	E	Clear, Vertical Base Up ±15° (30)*	(35)*	23000	16100	15000	8 ¹ / ₄	5	4200	65
									15000	20000				
		26319	MVR250/C/VBU/PA	12	E	Coated, Vertical Base Up ±15° (30)*	(35)*	21500	15100	15000	8 ¹ / ₄	5	3900	65
									14700	20000				
320 WATTS														
ED28	Mog	27501	MVR320/VBU/PA	12	E	Clear, Vertical Base Up ±15°	M132	31000	18000	15000	8 ¹ / ₄	5	4000	65
400 WATTS														
ED37	Mog	12642	MVR400/VBU/PA	6	0	Clear, Vertical Base Up ±15° (30)*	(36)*	44000	33900	20000	11 ¹⁵ / ₁₆	7	4000	65
									31700	30000				
		12644	MVR400/C/VBU/PA	6	0	Coated, Vertical Base Up ±15° (30)*	(36)*	42000	30250	20000	11 ¹⁵ / ₁₆	7	4000	65
									28200	30000				
MULTI-VAPOR® METAL HALIDE LAMPS														
150 WATTS — WATT-MISER® ENERGY-SAVING REPLACEMENT FOR 175W METAL HALIDE														
ED28	Mog	13481	➤ MVR150/U/WM	12	E	Clear, Watt-Miser®	M57	13500 V	8500 V	10000 V	8 ¹ / ₄	5	4000	65
								11500 H	7200 H	7500 H				
		13490	➤ MVR150/C/U/WM	12	E	Coated, Watt-Miser®	M57	12800 V	8000 V	10000 V	8 ¹ / ₄	5	3700	70
								10900 H	6900 H	7500 H				

† In actual applications, mean lumens will be higher for Metal Halide lamps operated on CW or CWA ballasts

To save energy costs, find the bulbs with the light output you need, then choose the one with the lowest watts.

(*) * All footnote references found at the end of this section. ➤ Reduced Wattage / High Color Rendering. To convert inches to millimeters, multiply by 25.4.

Bulb	Base	Product Code	Lamp Description	Case Qty.	Fix. Req.	Additional Information	ANSI Ballast Type	Lumens Initial	Lumens Mean [†]	Rated Avg. Life Hours	MOL in.	LCL in.	Color Temp. K	CRI
MULTI-VAPOR® METAL HALIDE LAMPS (Continued)														
175 WATTS														
BD17	Med	18902	MVR175/U/MED	6	E	Clear	M57	13600 V 11700 H	8600 V 7400 H	10000 V 6000 H	5 ³ / ₄	3 ⁷ / ₁₆	4000	65
		26432	MVR175/U/MED/CP	4	E	Clear, Consumer Pack	M57	13600 V 11700 H	8600 V 7400 H	10000 V 6000 H	5 ³ / ₄	3 ⁷ / ₁₆	4000	65
		19976	MVR175/C/U/MED	6	E	Coated	M57	12900 V 11900 H	8200 V 7900 H	10000 V 6000 H	5 ³ / ₄	3 ⁷ / ₁₆	3900	65
ED28	Mog	47760	MVR175/U	12	E	Clear	M57	13600 V 11700 H	8600 V 7400 H	10000 V 6000 H	8 ¹ / ₄	5	4000	65
		26433	MVR175/U/CP	4	E	Clear, Consumer Pack	M57	13600 V 11700 H	8600 V 7400 H	10000 V 6000 H	8 ¹ / ₄	5	4000	65
		47761	MVR175/C/U	12	E	Coated	M57	12900 V 11900 H	8200 V 7900 H	10000 V 6000 H	8 ¹ / ₄	5	3900	70
		17634	MVR175/SP30/U	12	E	RE730 Phosphor Coating	M57	12000 V 10300 H	7600 V 6500 H	10000 V 6000 H	8 ¹ / ₄	5	3000	70
PAR38	Med	25218	MVR175/PAR38/FL/1	6	E	Clear, One-piece PAR, Flood, 50° Beam Spread, 6,500 CBCP	M57	12000 V	7600 V	7500 V	5 ⁵ / ₈		3800	65
250 WATTS														
ED28	Mog	42729	MVR250/U	12	E	Clear	M58	20800 V 19100 H	13500 V 12400 H	10000 V 6000 H	8 ¹ / ₄	5	4200	65
		26434	MVR250/U/CP	4	E	Clear, Consumer Pack	M58	20800 V 19100 H	13500 V 12400 H	10000 V 6000 H	8 ¹ / ₄	5	4200	65
		42731	MVR250/C/U	12	E	Coated	M58	19800 V 18200 H	12600 V 11600 H	10000 V 6000 H	8 ¹ / ₄	5	3900	70
		17633	MVR250/SP30/U	12	E	RE730 Phosphor Coating	M58	18000 V 16600 H	11500 V 10600 H	10000 V 6000 H	8 ¹ / ₄	5	3000	70
360 WATTS — WATT-MISER® ENERGY-SAVING REPLACEMENT FOR 400W METAL HALIDE														
ED37	Mog	13495	MVR360/VBU/WM	6	0	Clear, Vertical Base Up ±15°, Watt-Miser® (32)*	M59	36000	24000	20000	11 ⁵ / ₁₆	7	4000	65
		13496	MVR360/C/VBU/WM	6	0	Coated, Vertical Base Up ±15°, Watt-Miser® (32)*	M59	35000	21000	20000	11 ⁵ / ₁₆	7	3700	70
400 WATTS														
ED37	Mog	43828	MVR400/U	6	V	Clear	M59	36000 V 33100 H	24000 V 22100 H	20000 V 15000 H	11 ⁵ / ₁₆	7	4000	65
		26435	MVR400/U/CP	4	V	Clear, Consumer Pack	M59	36000 V 33100 H	24000 V 22100 H	20000 V 15000 H	11 ⁵ / ₁₆	7	4000	65
		43829	MVR400/C/U	6	V	Coated	M59	35000 V 32200 H	21000 V 19300 H	20000 V 15000 H	11 ⁵ / ₁₆	7	3700	70
		17632	MVR400/SP30/U	6	V	RE730 Phosphor Coating	M59	31000 V 28500 H	18600 V 17100 H	20000 V 15000 H	11 ⁵ / ₁₆	7	3000	70
ED28	Mog	18904	MVR400/U/ED28	12	E	Clear, Compact Bulb	M59	36000 V 33100 H	24000 V 22100 H	20000 V 15000 H	8 ¹ / ₄	5	4000	65
		19979	MVR400/C/U/ED28	12	E	Coated, Compact Bulb	M59	35000 V 32200 H	21000 V 19300 H	20000 V 15000 H	8 ¹ / ₄	5	3700	70
1000 WATTS														
BT56	Mog	41826	MVR1000/U	6	V	Clear	M47	105000 V 96600 H	66000 V 60700 H	12000 V 9000 H	15 ³ / ₈	9 ¹ / ₂	4000	65
		41827	MVR1000/C/U	6	V	Coated	M47	99800 V 91800 H	59900 V 55100 H	12000 V 9000 H	15 ³ / ₈	9 ¹ / ₂	3400	70
BT37	Mog	18205	MVR1000/U/BT37	6	E	Clear, Compact Bulb	M47	105000 V 96600 H	66000 V 60700 H	12000 V 8000 H	11 ¹ / ₂	7	4000	65

[†] In actual applications, mean lumens will be higher for Metal Halide lamps operated on CW or CWA ballasts

To save energy costs, find the bulbs with the light output you need, then choose the one with the lowest watts.

() * All footnote references found at the end of this section. ➤ Reduced Wattage / High Color Rendering. To convert inches to millimeters, multiply by 25.4.

Bulb	Base	Product Code	Lamp Description	Case Qty.	Fix. Req.	Additional Information	ANSI Ballast Type	Lumens Initial	Lumens Mean†	Rated Avg. Life Hours	MOL in.	LCL in.	Temp. K	Color CRI
HIGH OUTPUT MULTI-VAPOR® METAL HALIDE LAMPS														
175 WATTS														
ED23½	Mog	11420	MXR175/VBD	6	E	Clear, Vertical Base Down ±15°, Integral Ignitor (13)*	M57	17200	13400	10000	7¾	5	3200	70
		11417	MXR175/VBU	6	E	Clear, Vertical Base Up ±15°, Integral Ignitor (13)*	M57	17200	13400	10000	7¾	5	3200	70
		11203	MXR175/C/VBU	6	E	Coated, Vertical Base Up ±15°, Integral Ignitor (13)*	M57	16300	12500	10000	7¾	5	3200	70
ED28	Pos Mog	18104	MVR175/HOR	12	E	Clear, Horizontal Burn ±15°, Position-oriented Socket Required	M57	15000	7700	10000	8¼	5	4000	65
		18105	MVR175/C/HOR	12	E	Coated, Horizontal Burn ±15°, Position-oriented Socket Required	M57	14100	7500	10000	8¼	5	3500	70
250 WATTS														
ED28	Pos Mog	18101	MVR250/HOR	12	E	Clear, Horizontal Burn ±15°, Position-oriented Socket Required	M58	21000	10000	15000	8¼	5	4200	65
		18103	MVR250/C/HOR	12	E	Coated, Horizontal Burn ±15°, Position-oriented Socket Required	M58	19700	9400	15000	8¼	5	3600	70
360 WATTS — WATT-MISER® ENERGY-SAVING REPLACEMENT FOR 400W METAL HALIDE														
ED37	Mog	40053	↔ MVR360/VBU/WM/XHO	6	0	Clear, Vertical Base Up ±15°, Watt-Miser®, High Output (32)*	M59	39000	24300	20000	11 ⁵ / ₁₆	7	4200	65
		40055	↔ MVR360/C/VBU/WM/XHO	6	0	Coated, Vertical Base Up ±15°, Watt-Miser®, High Output (32)*	M59	37500	22500	20000	11 ⁵ / ₁₆	7	4000	70
400 WATTS														
ED37	Mog	26865	MVR400/VBU/STB	6	E	Clear, Vertical Base Up ±15° Staybright™	M59	41000	31200	20000	11 ⁵ / ₁₆	7	4000	65
		26866	MVR400/C/VBU/STB	6	E	Coated, Vertical Base Up ±15° Staybright™	M59	41000	27700	20000	11 ⁵ / ₁₆	7	3700	70
		49657	MVR400/VBU	6	0	Clear, Vertical Base Up ±15°	M59	41000	25500	20000	11 ⁵ / ₁₆	7	4000	65
		49656	MVR400/C/VBU	6	0	Coated, Vertical Base Up ±15°	M59	41000	25000	20000	11 ⁵ / ₁₆	7	3700	70
		49655	MVR400/VBD	6	0	Clear, Vertical Base Down ±15°	M59	41000	25500	20000	11 ⁵ / ₁₆	7	4000	65
BT28	Mog	40335	MVR400/VBU/BT28	6	E	Clear, Vertical Base Up ±15°, Compact Bulb	M59	41000	25500	20000	11 ⁵ / ₁₆	7	4000	65
ED37	Mog	20931	↗ MVR400/SP30/VBU	6	0	RE730 Phosphor Coating, Vertical Base Up ±15°	M59	34000	20400	20000	11 ⁵ / ₁₆	7	3200	70
		13923	MVR400/VBU/XHO	6	0	Clear, Vertical Base Up ±15°	M59	44000	27400	20000	11 ⁵ / ₁₆	7	4000	65
		13924	MVR400/C/VBU/XHO	6	0	Coated, Vertical Base Up ±15°	M59	43000	25800	20000	11 ⁵ / ₁₆	7	3700	70
BT28	Mog	40201	MVR400/HOR/BT28	12	E	Clear, Horizontal Burn ±15°, Fits Standard or Position-oriented Socket, Compact Bulb	M59	37000	22000	20000	8 ³ / ₁₀	5	4200	65
BT37	Mog	26218	MVR400/HOR/MOG	6	E	Clear, Horizontal Burn ±15°, Fits Standard or Position-oriented Socket	M59	38000	22500	20000	11½	7	4200	65
		26219	MVR400/C/HOR/MOG	6	E	Coated, Horizontal Burn ±15°, Fits Standard or Position-oriented Socket	M59	36800	22000	20000	11½	7	3900	70

† In actual applications, mean lumens will be higher for Metal Halide lamps operated on CW or CWA ballasts

To save energy costs, find the bulbs with the light output you need, then choose the one with the lowest watts.

(*) * All footnote references found at the end of this section. ↔ Reduced Wattage ↗ High Color Rendering. To convert inches to millimeters, multiply by 25.4.

Bulb	Base	Product Code	Lamp Description	Case Qty.	Fix. Req.	Additional Information	ANSI Ballast Type	Lumens Initial	Lumens Mean [†]	Rated Avg. Life Hours	MOL in.	LCL in.	Temp. K	Color CRI
HIGH OUTPUT MULTI-VAPOR® METAL HALIDE LAMPS (CONTINUED)														
1000 WATTS														
BT56	Mog	44835	MVR1000/VBU	6	0	Clear, Vertical Base Up ±15°	M47	115000	72300	12000	15 ³ / ₈	9 ¹ / ₂	3800	65
		13137	MVR1000/C/VBU	6	0	Coated, Vertical Base Up ±15°	M47	110000	66000	12000	15 ³ / ₈	9 ¹ / ₂	3400	70
1500 WATTS														
BT56	Mog	37405	MVR1500/HBU	6	E	Clear, Base Up to 15° Below Horizontal (16, 17)*	M48	155000 V 146000 H	126000 V 119000 H	3000 V 3000 H	15 ³ / ₈	9 ¹ / ₂	3600	65
		37406	MVR1500/HBD	6	E	Clear, Base Down to 15° Above Horizontal (16, 17)*	M48	155000 V 146000 H	126000 V 119000 H	3000 V 3000 H	15 ³ / ₈	9 ¹ / ₂	3600	65
BT56	Pos Mog	27246	MVR1500/HOR	6	E	Clear, Horizontal Burn ±60°, Position-oriented Socket Required (17)*	M48	162000	132000	3000	15 ³ / ₈	9 ¹ / ₂	3400	65
1650 WATTS														
BT56	Pos Mog	25532	MVR1650/HOR	6	E	Clear, Horizontal Burn ±60°, Position-oriented Socket Required (17)*	M112	177000	145000	3000	15 ³ / ₈	9 ¹ / ₂	3200	65
PROTECTED HIGH OUTPUT MULTI-VAPOR® METAL HALIDE LAMPS														
32 WATTS														
ED17	Med	12651	MXR32/C/VBD/O	6	0	Coated, Vertical Base Down ±15°	M100	2400	1700	10000	5 ⁷ / ₁₆	3 ⁷ / ₁₆	3200	70
		16469	MXR32/C/VBU/O	6	0	Coated, Vertical Base Up ±15°	M100	2400	1700	10000	5 ⁷ / ₁₆	3 ⁷ / ₁₆	3200	70
70 WATTS														
ED17	Med	12377	MXR70/U/MED/O	6	0	Clear	M98	5500	3500	12000	5 ⁷ / ₁₆	3 ⁷ / ₁₆	3200	70
		12577	MXR70/C/U/MED/O	6	0	Coated	M98	5300	3300	12000	5 ⁷ / ₁₆	3 ⁷ / ₁₆	3200	70
100 WATTS														
ED17	Med	12381	MXR100/U/MED/O	6	0	Clear	M90	9000	6200	15000	5 ⁷ / ₁₆	3 ⁷ / ₁₆	3200	70
		12579	MXR100/C/U/MED/O	6	0	Coated	M90	8500	5900	15000	5 ⁷ / ₁₆	3 ⁷ / ₁₆	3200	70
360 WATTS WATT-MISER® ENERGY-SAVING REPLACEMENT FOR 400W METAL HALIDE														
ED37	Mog	40056	MPR360/VBU/WM/O	6	0	Clear, Vertical Base Up ±15°, Shrouded Arc Tube, Watt-Miser® (32)*	M59	36000	24000	20000	11 ⁵ / ₁₆	7	4000	65
400 WATTS														
ED37	Mog	18708	MPR400/VBU/O	6	0	Clear, Vertical Base Up ±15°, Shrouded Arc Tube	M59	40000	24900	20000	11 ⁵ / ₁₆	7	3400	65
		13582	MPR400/C/VBU/O	6	0	Coated, Vertical Base Up ±15°, Shrouded Arc Tube	M59	38000	22800	20000	11 ⁵ / ₁₆	7	3200	70
CHROMAFIT™ MULTI-VAPOR® METAL HALIDE LAMPS (HPS RETROFIT LAMPS)														
250 WATTS														
ED28	Mog	12762	MVR250/VBU/R	12	E	Clear HPS Retrofit, Vertical Base Up ±15°	S50	18500	13900	10000	8 ¹ / ₄	5 ³ / ₄	4500	65
		12769	MVR250/C/VBU/R	12	E	Coated HPS Retrofit, Vertical Base Up ±15°	S50	18000	13000	10000	8 ¹ / ₄	5 ³ / ₄	4000	70
400 WATTS														
ED28	Mog	26851	MVR400/U/ED28/R	12	E	Clear HPS Retrofit, Compact Bulb	S51	36000 V 33100 H	22000 V 20200 H	20000 V 15000 H	8 ⁵ / ₁₆	5	4000	65
ED37	Mog	12770	MVR400/VBU/R	6	0	Clear HPS Retrofit, Vertical Base Up ±15°	S51	37600	22600	20000	11 ¹ / ₂	5 ³ / ₄	4500	65
		12772	MVR400/C/VBU/R	6	0	Coated HPS Retrofit, Vertical Base Up ±15°	S51	35700	21400	20000	11 ¹ / ₂	5 ³ / ₄	4000	70

[†] In actual applications, mean lumens will be higher for Metal Halide lamps operated on CW or CWA ballasts

To save energy costs, find the bulbs with the light output you need, then choose the one with the lowest watts.

() * All footnote references found at the end of this section. ↗ Reduced Wattage ↘ High Color Rendering. To convert inches to millimeters, multiply by 25.4.

Bulb	Base	Product Code	Lamp Description	Case Qty.	Fix. Req.	Additional Information	ANSI Ballast Type	Lumens Initial	Lumens Mean†	Rated Avg. Life Hours	MOL in.	LCL in.	Temp. K	Color CRI
I-LINE MULTI-VAPOR® METAL HALIDE LAMPS (MERCURY RETROFIT LAMPS)														
325 WATTS WATT-MISER® ENERGY-SAVING REPLACEMENT FOR 400W MERCURY														
ED37	Mog	10687	➤ MVR325/I/U/WM	6	V	Clear, Energy-saving Retrofit for 400W Mercury, Watt-Miser®	H33	28000 V 25800 H	13300 V 12200 H	20000 V 10000 H	11 ⁵ / ₁₆	7	4000	65
		10688	➤ MVR325/C/I/U/WM	6	V	Coated, Energy-saving Retrofit for 400W Mercury, Watt-Miser®	H33	26300 V 24200 H	12900 V 11800 H	20000 V 10000 H	11 ⁵ / ₁₆	7	3700	70
400 WATTS														
ED37	Mog	43817	MVR400/I/U	6	V	Clear, Retrofit for 400W Mercury	H33 or M59	36000 V 33100 H	24000 V 22100 H	15000 V 10000 H	11 ⁵ / ₁₆	7	4000	65
		43818	MVR400/C/I/U	6	V	Coated, Retrofit for 400W Mercury	H33 or M59	35000 V 32200 H	21000 V 19300 H	15000 V 10000 H	11 ⁵ / ₁₆	7	3700	70
950 WATTS ENERGY-SAVING REPLACEMENT FOR 1000W MERCURY														
BT56	Mog	39097	➤ MVR950/I/VBU	6	0	Clear, Energy-saving Retrofit for 1000W Mercury, Vertical Base Up ±15°	H36 or M47	100000	62900	12000	15 ¹ / ₁₆	9 ¹ / ₂	3800	65
SAF-T-GARD® SELF-EXTINGUISHING MULTI-VAPOR® METAL HALIDE LAMPS														
400 WATTS														
ED37	Mog	11146	MVT400/I/U	6	V	Clear, Retrofit for 400W Mercury	H33 or M59	36000 V 33100 H	24000 V 22100 H	15000 V 10000 H	11 ⁵ / ₁₆	7	4000	65
		11119	MVT400/C/I/U	6	V	Coated, Retrofit for 400W Mercury	H33 or M59	35000 V 32200 H	21000 V 19300 H	15000 V 10000 H	11 ⁵ / ₁₆	7	3700	70
		11144	MVT400/VBU	6	0	Clear, Vertical Base Up ±15°	M59	41000	25500	20000	11 ⁵ / ₁₆	7	4000	65
		11145	MVT400/C/VBU	6	0	Coated, Vertical Base Up ±15°	M59	41000	22000	20000	11 ⁵ / ₁₆	7	3700	70
ARCSTREAM™ METAL HALIDE LAMPS														
70 WATTS														
T6	R7s	17443	➤ ARC70/TD/730/R7S	12	E	Clear, Horizontal ±45°	M85	6000	4800	6000	4 ¹ / ₁₆		3000	75
		34592	➤ ARC70/TD/742/R7S	12	E	Clear, Horizontal ±45°	M85	6000	4500	6000	4 ¹ / ₁₆		4200	75
150 WATTS														
Capsule BiPin GY9.5		34813	➤ CSS150/CAP/50	10	E	Clear, Disco Lamp	M81	10000	8000	1000	1 ⁵ / ₈	1 ¹ / ₈	5000	80
T6	BiPin G12	21053	➤ ARC150/T/U/830/G12	10	E	Clear	M81	12000	9500	6000	3	2 ¹ / ₄	3000	80
		21054	➤ ARC150/T/U/840/G12	10	E	Clear	M81	11500	10500	6000	3	2 ¹ / ₄	4000	80
T7	R7s	30095	➤ ARC150/TD/730/R7S-24	12	E	Clear, Horizontal ±45°	M81	13000	11000	6000	5 ³ / ₈		3000	75
		17445	➤ ARC150/TD/742/R7S-24	12	E	Clear, Horizontal ±45°	M81	12000	10000	6000	5 ³ / ₈		4200	75
PAR64	Ex Mog End Pr	30080	➤ MBI150/PAR64/30M	1	0	Clear, Medium Beam, 13° Beam Spread, 50,000 CBCP	M81	11500	9000	6000	5 ¹ / ₄		3000	80
		21285	➤ MBI150/PAR64/30N	1	0	Clear, Narrow Beam, 3° Beam Spread, 300,000 CBCP	M81	11500	9000	6000	5 ¹ / ₄		3000	80
250 WATTS														
T15	Mog	26683	➤ ARC250/T/H/960/E39	12	E	Clear, Horizontal ±45°, Daylight Color	M80	19000	13300	10000	8 ³ / ₈	5 ⁵ / ₈	6000	90
400 WATTS														
ED18	Mog	26685	➤ KRC400/T/H/960/E39	12	E	Clear, Horizontal ±45°, Daylight Color	(40)*	25000	17500	10000	10 ¹ / ₂	6 ³ / ₄	6000	90

† In actual applications, mean lumens will be higher for Metal Halide lamps operated on CW or CWA ballasts

To save energy costs, find the bulbs with the light output you need, then choose the one with the lowest watts.

(*) * All footnote references found at the end of this section. ➤ Reduced Wattage / High Color Rendering. To convert inches to millimeters, multiply by 25.4.

Bulb	Base	Product Code	Lamp Description	Case Qty.	Fix. Req.	Additional Information	ANSI Ballast Type	Lumens Initial	Lumens Mean [†]	Rated Avg. Life Hours	MOL in.	LCL in.	Color Temp. K	CRI
ARCSTREAM™ METAL HALIDE LAMPS (Continued)														
1000 WATTS														
PAR64	G38	29333	✓ SPL1000/PAR64/840/G38	1	E	Clear, Narrow Spot, 6° Beam Spread, 1,350,000 CBCP, Sportlight	(38)*	63000	53000	3500	6 ⁷ / ₈	4000	80	
		29336	✓ SPL1000/PAR64/840/HR/G38	1	E	Clear, Narrow Spot, 6° Beam Spread, 1,350,000 CBCP, Hot Restrike, Sportlight	(38)*	63000	53000	3500	6 ⁷ / ₈	4000	80	
1500 WATTS														
T7	Rx7s	30061	SPL1500/L/H/652/RX7SM	1	E	Frosted, Horizontal ±15°, Sportlight	(37)*	120000	90000	6000	10 ¹ / ₈	5	5200	65
LUCALOX® HIGH PRESSURE SODIUM LAMPS														
35 WATTS														
B17	Med	11668	LU35/MED	6	0	Clear	S76	2250	2025	16000	5 ⁷ / ₁₆	3 ⁷ / ₁₆	1900	22
		26420	LU35/MED/CP	4	0	Clear, Consumer Pack	S76	2250	2025	16000	5 ⁷ / ₁₆	3 ⁷ / ₁₆	1900	22
		11669	LU35/D/MED	6	0	Diffuse	S76	2150	1935	16000	5 ⁷ / ₁₆	3 ⁷ / ₁₆	1900	22
50 WATTS														
B17	Med	11345	LU50/MED	6	0	Clear	S68	4000	3600	24000 +	5 ⁷ / ₁₆	3 ⁷ / ₁₆	1900	22
		26421	LU50/MED/CP	4	0	Clear, Consumer Pack	S68	4000	3600	24000 +	5 ⁷ / ₁₆	3 ⁷ / ₁₆	1900	22
		11347	LU50/D/MED	6	0	Diffuse	S68	3800	3420	24000 +	5 ⁷ / ₁₆	3 ⁷ / ₁₆	1900	22
ED23 ¹ / ₂	Mog	44975	LU50	12	0	Clear	S68	4000	3600	24000 +	7 ³ / ₄	5	1900	22
		26425	LU50/CP	4	0	Clear, Consumer Pack	S68	4000	3600	24000 +	7 ³ / ₄	5	1900	22
		45006	LU50/D	12	0	Diffuse	S68	3800	3420	24000 +	7 ³ / ₄	5	1900	22
70 WATTS														
B17	Med	11339	LU70/MED	6	0	Clear	S62	6400	5450	24000 +	5 ⁷ / ₁₆	3 ⁷ / ₁₆	1900	22
		26422	LU70/MED/CP	4	0	Clear, Consumer Pack	S62	6400	5450	24000 +	5 ⁷ / ₁₆	3 ⁷ / ₁₆	1900	22
		11340	LU70/D/MED	6	0	Diffuse	S62	5950	5050	24000 +	5 ⁷ / ₁₆	3 ⁷ / ₁₆	1900	22
ED23 ¹ / ₂	Mog	44033	LU70	12	0	Clear	S62	6400	5450	24000 +	7 ³ / ₄	5	1900	22
		26426	LU70/CP	4	0	Clear, Consumer Pack	S62	6400	5450	24000 +	7 ³ / ₄	5	1900	22
		44035	LU70/D	12	0	Diffuse	S62	5950	5050	24000 +	7 ³ / ₄	5	1900	22
		19264	LU70/SBY/LL	12	0	Clear, Standby Longlife, Dual Arc Tube	S62	6400	5050	40000	7 ³ / ₄	5	1900	22
100 WATTS														
B17	Med	13250	LU100/MED	6	0	Clear	S54	9500	8550	24000 +	5 ¹ / ₂	3 ⁷ / ₁₆	2000	22
		26423	LU100/MED/CP	4	0	Clear, Consumer Pack	S54	9500	8550	24000 +	5 ¹ / ₂	3 ⁷ / ₁₆	2000	22
		13251	LU100/D/MED	6	0	Diffuse	S54	8800	7920	24000 +	5 ¹ / ₂	3 ⁷ / ₁₆	2000	22
ED23 ¹ / ₂	Mog	44037	LU100	12	0	Clear	S54	9500	8550	24000 +	7 ³ / ₄	5	2000	22
		26427	LU100/CP	4	0	Clear, Consumer Pack	S54	9500	8550	24000 +	7 ³ / ₄	5	2000	22
		44038	LU100/D	12	0	Diffuse	S54	8800	7920	24000 +	7 ³ / ₄	5	2000	22
		19265	LU100/SBY/LL	12	0	Clear, Standby Longlife, Dual Arc Tube	S54	9500	8190	40000	7 ³ / ₄	5	2000	22

[†] In actual applications, mean lumens will be higher for Metal Halide lamps operated on CW or CWA ballasts

To save energy costs, find the bulbs with the light output you need, then choose the one with the lowest watts.

(*) * All footnote references found at the end of this section. ⚡ Reduced Wattage ✓ High Color Rendering. To convert inches to millimeters, multiply by 25.4.

Bulb	Base	Product Code	Lamp Description	Case Qty.	Fix. Req.	Additional Information	ANSI Ballast Type	Lumens Initial	Lumens Mean	Rated Avg. Life Hours	MOL in.	LCL in.	Temp. K	Color CRI
LUCALOX® HIGH PRESSURE SODIUM LAMPS (Continued)														
150 WATTS														
B17	Med	13252	LU150/MED	6	0	Clear	S55	16000	14400	24000 +	5 ³ / ₄	3 ¹ / ₂	2000	22
		26424	LU150/MED/CP	4	0	Clear, Consumer Pack	S55	16000	14400	24000 +	5 ³ / ₄	3 ¹ / ₂	2000	22
		13253	LU150/D/MED	6	0	Diffuse	S55	15000	13500	24000 +	5 ³ / ₄	3 ¹ / ₂	2000	22
ED23 ¹ / ₂	Mog	44043	LU150/55	12	0	Clear	S55	16000	14400	24000 +	7 ³ / ₄	5	2000	22
		26429	LU150/55/CP	4	0	Clear, Consumer Pack	S55	16000	14400	24000 +	7 ³ / ₄	5	2000	22
		44045	LU150/55/D	12	0	Diffuse	S55	15000	13500	24000 +	7 ³ / ₄	5	2000	22
		19266	LU150/55/SBY/LL	12	0	Clear, Standby Longlife, Dual Arc Tube	S55	16000	14000	40000	7 ³ / ₄	5	2000	22
ED28	Mog	44243	LU150/100	12	0	Clear	S56	15000	13500	24000 +	8 ⁵ / ₁₆	5	2000	22
		18245	LU150/100/D	12	0	Diffuse	S56	14000	12600	24000 +	8 ⁵ / ₁₆	5	2000	22
200 WATTS														
ED18	Mog	44206	LU200	12	0	Clear	S66	22000	19800	24000 +	9 ³ / ₄	5 ³ / ₄	2100	22
		23431	LU200/SBY/LL	12	0	Clear, Standby Longlife, Dual Arc Tube	S66	21500	18150	40000	9 ³ / ₄	5 ³ / ₄	2100	22
250 WATTS														
ED18	Mog	44047	LU250	12	0	Clear	S50	28000	27000	24000 +	9 ³ / ₄	5 ³ / ₄	2100	22
		26430	LU250/CP	4	0	Clear, Consumer Pack	S50	28000	27000	24000 +	9 ³ / ₄	5 ³ / ₄	2100	22
		44049	LU250/S	12	0	Clear, Extra Light	S50	30000	28000	24000 +	9 ³ / ₄	5 ³ / ₄	2100	22
		19270	LU250/SBY/LL	12	0	Clear, Standby Longlife, Dual Arc Tube	S50	27500	24750	40000	9 ³ / ₄	5 ³ / ₄	2100	22
ED28	Mog	44051	LU250/D	12	0	Diffuse	S50	26000	23400	24000 +	9	5	2100	22
310 WATTS														
ED18	Mog	44053	LU310	12	0	Clear	S67	37000	33300	24000 +	9 ³ / ₄	5 ³ / ₄	2100	22
400 WATTS														
ED18	Mog	44054	LU400	12	0	Clear	S51	51000	45000	24000 +	9 ³ / ₄	5 ³ / ₄	2100	22
		26431	LU400/CP	4	0	Clear, Consumer Pack	S51	51000	45000	24000 +	9 ³ / ₄	5 ³ / ₄	2100	22
		19272	LU400/SBY/LL	12	0	Clear, Standby Longlife, Dual Arc Tube	S51	50000	45000	40000	9 ³ / ₄	5 ³ / ₄	2100	22
ED28	Mog	44056	LU400/D	6	0	Diffuse	S51	47500	42750	24000 +	11 ⁵ / ₁₆	7	2100	22
T7	Rx7s	30244	LU400/TD	10	0	Clear, Double-ended, Horizontal Burn ±20°	S51	43000	37300	24000	10 ¹ / ₈		2000	25
600 WATTS														
T15	Mog	27187	LU600/T	12	0	Clear	S106	90000	81000	12000 +	11 ¹ / ₁₆	6 ⁵ / ₈	2000	25
750 WATTS														
ED37	Mog	14682	LU750	6	0	Clear	S111	110000	99000	24000 +	11 ¹ / ₂	6 ³ / ₄	2100	22
1000 WATTS														
E25	Mog	44058	LU1000	6	0	Clear	S52	140000	126000	24000 +	15 ¹ / ₁₆	8 ³ / ₄	2100	22
		27185	LU1000/SBY/LL	6	0	Clear, Standby Longlife, Dual Arc Tube	S52	127000	115000	40000	15 ¹ / ₁₆	8 ³ / ₄	2100	22
T7	Rx7s	30246	LU1000/TD	10	0	Clear, Double-ended, Horizontal Burn ±20°	S52	137500	118200	24000	13 ³ / ₁₆		2000	25

To save energy costs, find the bulbs with the light output you need, then choose the one with the lowest watts.

(*) * All footnote references found at the end of this section. ⚡ Reduced Wattage / High Color Rendering. To convert inches to millimeters, multiply by 25.4.

Bulb	Base	Product Code	Lamp Description	Case Qty.	Fix. Req.	Additional Information	ANSI Ballast Type	Lumens Initial	Lumens Mean	Rated Avg. Life Hours	MOL in.	LCL in.	Temp. K	CRI
ECOLUX® NC NON-CYCLING HIGH PRESSURE SODIUM LAMPS (TCLP COMPLIANT)														
70 WATTS														
ED23 ¹ / ₂	Mog	14672	LU70/ECO/NC	12	0	Clear, Non-Cycling	S62	6300	5370	24000	7 ³ / ₄	5	1900	23
100 WATTS														
ED23 ¹ / ₂	Mog	14673	LU100/ECO/NC	12	0	Clear, Non-Cycling	S54	10500	8550	24000	7 ³ / ₄	5	2000	23
150 WATTS														
ED23 ¹ / ₂	Mog	40390	LU150/ECO/NC	12	0	Clear, Non-Cycling	S55	16000	14400	24000	7 ³ / ₄	5	2000	23
250 WATTS														
ED18	Mog	14674	LU250/ECO/NC	12	0	Clear, Non-Cycling	S50	29000	27500	24000	9 ³ / ₄	5 ³ / ₄	2000	30
400 WATTS														
ED18	Mog	14675	LU400/ECO/NC	12	0	Clear, Non-Cycling	S54	54000	48000	24000	9 ³ / ₄	5 ³ / ₄	2100	30
DELUXE LUCALOX® HIGH PRESSURE SODIUM LAMPS														
70 WATTS														
B17	Med	16611	LU70/DX/MED	6	0	Clear, Improved CRI	S62	3800	3040	10000	5 ¹ / ₂	3 ¹ / ₂	2200	65
150 WATTS														
B17	Med	18094	LU150/DX/MED	6	0	Clear, Improved CRI	S55	10500	9135	15000	5 ³ / ₄	3 ¹ / ₂	2200	65
ED23 ¹ / ₂	Mog	18092	LU150/55/DX	12	0	Clear, Improved CRI	S55	10500	9135	15000	7 ³ / ₄	5	2200	65
250 WATTS														
ED18	Mog	11785	LU250/DX	12	0	Clear, Improved CRI	S50	22500	20700	15000	9 ³ / ₄	5 ³ / ₄	2200	65
400 WATTS														
ED28	Mog	19650	LU400/DX	12	0	Clear, Improved CRI	S51	37400	34400	15000	9	5 ³ / ₁₆	2200	70
E-Z LUX® HIGH PRESSURE SODIUM LAMPS (MERCURY RETROFIT)														
150 WATTS														
ED28	Mog	49943	LUH150/EZ	12	0	Clear, Energy-saving Retrofit for 175W Mercury	H39	12500	12000	13000	9	5	1900	22
215 WATTS														
ED28	Mog	49939	LUH215/EZ	12	0	Clear, Energy-saving Retrofit for 250W Mercury	H37	20200	18600	12000	9	5	1900	22
360 WATTS														
BT37	Mog	18012	LUH360/EZ	6	0	Clear, Energy-saving Retrofit for 400W Mercury	H33	45000	40500	24000	11 ⁵ / ₁₆	7 ¹ / ₈	2100	25
SOX LOW PRESSURE SODIUM LAMPS														
18 WATTS														
T16	B22d	21294	SOX-18	16	E	Clear, Horizontal Burn ±20° or Vertical Base Up ±15°	L69	1800	1570	18000	8 ¹ / ₂	5 ³ / ₈	1800	0
35 WATTS														
T16	B22d	21296	SOX-35	16	E	Clear, Horizontal Burn ±20° or Vertical Base Up ±15°	L70	4600	4000	18000	12 ¹ / ₄	7 ¹ / ₄	1800	0
55 WATTS														
T16	B22d	21297	SOX-55	16	E	Clear, Horizontal Burn ±20° or Vertical Base Up ±15°	L71	7650	6655	18000	16 ³ / ₄	9 ¹ / ₂	1800	0
90 WATTS														
T21	B22d	21298	SOX-90	9	E	Clear, Horizontal Burn ±20°	L72	12750	11095	16000	20 ³ / ₄	11 ¹ / ₂	1800	0

To save energy costs, find the bulbs with the light output you need, then choose the one with the lowest watts.

(*) * All footnote references found at the end of this section. ➔ Reduced Wattage / High Color Rendering. To convert inches to millimeters, multiply by 25.4.

Bulb	Base	Product Code	Lamp Description	Case Qty.	Fix. Req.	Additional Information	ANSI Ballast Type	Lumens Initial	Lumens Mean	Rated Avg. Life Hours	MOL in.	LCL in.	Temp. K	Color CRI
SOX LOW PRESSURE SODIUM LAMPS (Continued)														
135 WATTS														
T21	B22d	21299	SOX-135	9	E	Clear, Horizontal Burn ±20°	L73	22000	19140	16000	30 ¹ / ₂	16 ³ / ₈	1800	0
180 WATTS														
T21	B22d	30203	SOX-180	9	E	Clear, Horizontal Burn ±20°	L74	32000	27800	16000	44 ¹ / ₈	22 ⁷ / ₈	1800	0
MERCURY LAMPS														
40/50 WATTS														
B17	Med	12460	HR40/50DX45	5	0	40W on H45 Ballast, 50W on H46 Ballast, Deluxe White	H45 H46	1140 1575	910 1250	6000 6000	5 ¹ / ₈	3 ¹ / ₈	3900	50
75 WATTS														
B17	Med	12461	HR75DX43	5	0	Deluxe White	H43	2700	2250	16000	5 ⁷ / ₁₆	3 ¹ / ₂	3900	50
100 WATTS														
A23 ¹ / ₂	Med	12464	HR100A38/A23	5	0	Clear	H38	3700	2400	18000	5 ⁷ / ₁₆	3 ¹ / ₂	5700	15
		12467	HR100DX38/A23	5	0	Deluxe White	H38	4000	2600	18000	5 ⁷ / ₁₆	3 ¹ / ₂	3800	50
B17	Med	17113	HR100DX38/MED	5	0	Deluxe White	H38	4000	2600	18000	5 ⁷ / ₁₆	3 ¹ / ₂	3900	50
ED23 ¹ / ₂	Mog	12471	HR100A38	5	0	Clear	H38	3850	2500	24000 +	7 ¹ / ₂	5	5700	15
		22575	HR100DX38	12	0	Deluxe White	H38	4000	2600	24000 +	7 ¹ / ₂	5	3900	50
		26437	HR100DX38/CP	4	0	Deluxe White, Consumer Pack	H38	4000	2600	24000 +	7 ¹ / ₂	5	3900	50
PAR38	Admed Skrt	24040	HR100PSP44	12	0	PAR Spot, Landscape & Black Light, 15° Beam Spread	H44	2450	1700	12000	5 ⁷ / ₁₆		5700	15
PAR38	Med Skirt	19648	HR100PSP44/MED	12	0	PAR Spot, Landscape & Black Light, 15° Beam Spread	H44	2450	1700	12000	5 ⁷ / ₁₆		5700	15
		19647	HR100PFL44/MED	12	0	PAR Flood, Landscape & Black Light, 75° Beam Spread	H44	2450	1700	12000	5 ⁷ / ₁₆		5700	15
R40	Med	36238	HR100RFL38	12	0	Reflector Flood, 48° Beam Spread	H38	2450	2000	24000 +	7		5700	15
		36495	HR100RDXFL38	12	0	Deluxe White, Reflector WFL, 140° Beam Spread	H38	2450	2050	24000 +	7		3900	50
175 WATTS														
ED28	Mog	24048	HR175A39	12	0	Clear	H39	7850	6830	24000 +	8 ¹ / ₄	5	5700	15
		26440	HR175A39/CP	4	0	Clear, Consumer Pack	H39	7850	6830	24000 +	8 ¹ / ₄	5	5700	15
		24062	HR175DX39	12	0	Deluxe White	H39	7800	6800	24000 +	8 ¹ / ₄	5	3900	50
		26439	HR175DX39/CP	4	0	Deluxe White, Consumer Pack	H39	7800	6800	24000 +	8 ¹ / ₄	5	3900	50
R40	Med	24058	HR175RFL39	12	0	Clear, Reflector Flood, 40° Beam Spread	H39	5700	4800	24000 +	7		5700	15
		33026	HR175RDXFL39	12	0	Deluxe White, Reflector WFL, 120° Beam Spread	H39	5700	4350	24000 +	7		3900	50
R40	Mog	36445	HR175RFL39/M	12	0	Clear, Reflector Flood, 40° Beam Spread	H39	5700	4800	24000 +	7 ¹ / ₂		5700	15
250 WATTS														
ED28	Mog	24068	HR250A37	12	0	Clear	H37	11000	8250	24000	8 ¹ / ₄	5	5700	15
		32127	HR250DX37	12	0	Deluxe White	H37	11200	8400	24000 +	8 ¹ / ₄	5	3900	50

To save energy costs, find the bulbs with the light output you need, then choose the one with the lowest watts.

() * All footnote references found at the end of this section. ⚡ Reduced Wattage / High Color Rendering. To convert inches to millimeters, multiply by 25.4.

Bulb	Base	Product Code	Lamp Description	Case Qty.	Fix. Req.	Additional Information	ANSI Ballast Type	Lumens Initial	Lumens Mean	Rated Avg. Life Hours	MOL in.	LCL in.	Temp. K	Color CRI
MERCURY LAMPS (Continued)														
400 WATTS														
BT37	Mog	32313	HR400DX33/BT	6	0	Deluxe White	H33	22600	14400	24000 + 11 ⁵ / ₁₆	7	3900	50	
ED37	Mog	23974	HR400A33	6	0	Clear	H33	21000	13400	24000 + 11 ⁵ / ₁₆	7	5700	15	
		23998	HR400DX33	6	0	Deluxe White	H33	22600	14400	24000 + 11 ⁵ / ₁₆	7	3900	50	
R52	Mog	33879	HR400RDX33	6	0	Reflector, Deluxe White, 160° Beam Spread	H33	20800	13400	24000 + 11 ³ / ₄		3900	50	
R60	Mog	33938	HR400RDXFL33	6	0	Reflector WFL, Deluxe White, Clear Face, 110° Beam Spread	H33	15500	8950	24000 + 10 ¹ / ₈		3900	50	
T16	Mog	14873	H400A33/T16	6	0	Clear	H33	20000	18200	12000	11	7	5700	15
1000 WATTS														
BT56	Mog	24171	HR1000A36	6	0	Clear	H36	57000	28500	24000 + 15 ¹ / ₁₆	9 ¹ / ₂	5700	15	
		24191	HR1000DX36	6	0	Deluxe White	H36	58000	29000	24000 + 15 ¹ / ₁₆	9 ¹ / ₂	3900	50	
		32733	HR1000DX34	6	0	Deluxe White (28)*	H34	58300	29200	16000	15 ¹ / ₁₆	9 ³ / ₈	3900	50
SAF-T-GARD® MERCURY LAMPS														
175 WATTS														
ED28	Mog	43391	HT175DX39	12	0	Deluxe White	H39	7800	6800	16000	8 ¹ / ₄	5	3900	50
400 WATTS														
ED37	Mog	43363	HT400DX33	6	0	Deluxe White	H33	22600	14400	24000	11 ⁵ / ₁₆	7	3900	50
E-Z MERC® SELF-BALLASTED LAMPS (INCANDESCENT RETROFIT)														
160 WATTS														
ED24	Med	45178	HSB160/M	24	0	Deluxe White, 120V (9)*		2300	1600	12000	7	4 ⁹ / ₁₆	3900	50
250 WATTS														
ED28	Med	45174	HSB250/M	12	0	Deluxe White, 120V (9)*		5000	3750	12000	8 ¹ / ₂	5 ³ / ₁₆	3900	50
ED28	Mog	45176	HSB250	12	0	Deluxe White, 120V (9)*		5000	3750	12000	8 ¹ / ₂	5 ³ / ₁₆	3900	50
450 WATTS														
BT37	Mog	40122	HSB450	6	0	Deluxe White, 120V (9)*		9100	8280	16000	11 ¹³ / ₃₂	7 ³ / ₈	3900	50
750 WATTS														
R57	Mog	44012	HSB750R/120	6	0	Deluxe White, Reflector Flood, 120V, 130° Beam Spread (9)*		14000	11200	16000	12 ³ / ₄	8 ³ / ₈	3900	50

To save energy costs, find the bulbs with the light output you need, then choose the one with the lowest watts.

(*) * All footnote references found at the end of this section. ⚡ Reduced Wattage ✂ High Color Rendering. To convert inches to millimeters, multiply by 25.4.

Bulb	Base	Product Code	Lamp Description	Case Qty.	Fix. Req.	Additional Information	ANSI Ballast Type	Lumens Initial	Lumens Mean	Rated Avg. Life Hours	MOL in.	MOL (mm)	LCL in.	LCL (mm)	Color Temp. K	CRI
EXPORT LAMPS																
METAL HALIDE																
ED17	E27	16893	MXR32/C/VBU/O/27	6	0	Coated, Vertical Base Up $\pm 15^\circ$	M100	2400	1700	10000	5 1/2 (140)	3 1/2 (89)	3200	70		
BD17	E27	18686	MXR100/U/27	6	E	Clear		9000	6200	15000	5 1/2 (140)	3 1/2 (89)	3200	70		
		18684	MXR100/C/U/27	6	E	Coated		8500	5900	15000	5 1/2 (140)	3 1/2 (89)	3200	70		
ED23 1/2	E40	18952	MXR175/C/VBU/40	6	E	Coated, Vertical Base Up $\pm 15^\circ$, Integral Ignitor (13)*		16300	12500	10000	7 7/8 (200)	5 1/8 (130)	3200	70		
ED28	E40	47762	MVR175/U/40	12	E	Clear (14)*		13600	8600	10000	8 1/2 (216)	5 1/8 (130)	4000	65		
		47763	MVR175/C/U/40	12	E	Coated (14)*		12900	8200	10000	8 1/2 (216)	5 1/8 (130)	3900	70		
		17714	MVR175/SP30/U/40	12	E	RE730 Phosphor Coating (14)*		12000	7600	10000	8 1/2 (216)	5 1/8 (130)	3000	70		
		44542	MVR250/U/40	12	E	Clear (14)*		20800	13500	10000	8 1/2 (216)	5 1/8 (130)	4200	65		
		44543	MVR250/C/U/40	12	E	Coated (14)*		19800	12600	10000	8 1/2 (216)	5 1/8 (130)	3900	70		
ED37	E40	17715	MVR250/SP30/U/40	12	E	RE730 Phosphor Coating (14)*		18000	11500	10000	8 1/2 (216)	5 1/8 (130)	3000	70		
		43907	MVR400/U/40	6	V	Clear (14)*		36000	24000	20000	11 5/8 (295)	7 3/16 (183)	4000	65		
		43908	MVR400/C/U/40	6	V	Coated (14)*		35000	21000	20000	11 5/8 (295)	7 3/16 (183)	3700	70		
		17716	MVR400/SP30/U/40	6	V	RE730 Phosphor Coating (14)*		31000	18600	20000	11 5/8 (295)	7 3/16 (183)	3000	70		
		49860	MVR400/VBU/40	6	O	Clear, Vertical Base Up $\pm 15^\circ$		41000	25500	20000	11 5/8 (295)	7 3/16 (183)	4000	65		
ED37	E40	49857	MVR400/C/VBU/40	6	O	Coated, Vertical Base Up $\pm 15^\circ$		41000	25000	20000	11 5/8 (295)	7 3/16 (183)	3700	70		
		21440	MVR400/SP30/VBU/40	6	O	RE730 Phosphor Coating, Vertical Base Up $\pm 15^\circ$		34000	20400	20000	11 5/8 (295)	7 3/16 (183)	3200	70		
		18709	MPR400/VBU/O/40	6	O	Clear, Vertical Base Up $\pm 15^\circ$, Shrouded Arc Tube (32)*		40000	24900	20000	11 5/8 (295)	7 3/16 (183)	3400	65		
BT56	E40	41828	MVR1000/U/40	6	V	Clear		105000	66000	12000	15 5/32 (385)	9 5/32 (233)	4000	65		
		41829	MVR1000/C/U/40	6	V	Coated		99800	59900	12000	15 5/32 (385)	9 5/32 (233)	3400	70		
LUCALOX® HIGH PRESSURE SODIUM																
E21	E27	10405	LU70/90/27	12	0	Clear		6000	5400	24000 +	6 3/8 (160)	4 5/32 (106)	1900	22		
		27224	LU70/90/D/27	12	0	Diffuse		5800	5220	24000 +	6 3/8 (160)	4 5/32 (106)	1900	22		
ED23 1/2	E40	27230	LU100/100/D/40	12	0	Diffuse		9200	7820	24000 +	7 5/16 (186)	5 (127)	2000	22		
		44044	LU150/55/40	12	0	Clear		16000	14400	24000 +	7 15/16 (202)	5 5/32 (131)	2000	22		
T14 1/2	E40	27223	LU150/100/40	12	0	Clear		15000	13500	24000 +	8 1/4 (210)	5 5/32 (131)	2000	22		
ED28	E40	27228	LU150/100/D/40	12	0	Diffuse		14000	12600	24000 +	8 7/16 (214)	5 5/32 (131)	2000	22		
ED18	E40	44048	LU250/40	12	0	Clear		28000	27000	24000 +	9 15/16 (252)	5 29/32 (150)	2100	22		
ED28	E40	27226	LU250/D/40	12	0	Clear		26000	23400	24000 +	9 1/8 (232)	5 3/8 (137)	2100	22		
ED18	E40	44055	LU400/40	12	0	Clear		51000	45000	24000 +	9 15/16 (252)	5 29/32 (150)	2100	22		
ED37	E40	27229	LU400/D/40	6	0	Diffuse		47500	42750	24000 +	11 1/2 (292)	7 3/16 (183)	2100	22		
E25	E40	44059	LU1000/40	6	0	Clear		140000	126000	24000 +	15 3/16 (386)	8 13/16 (224)	2100	22		
T18	E40	44247	LU1000/T18/40	6	0	Clear		140000	126000	24000 +	15 1/16 (383)	8 13/16 (224)	2100	22		
E-Z LUX® LUCALOX® HIGH PRESSURE SODIUM (MERCURY RETROFIT)																
ED23 1/2	E27	11683	LUH110/D/27	12	0	Diffuse, Energy-saving Retrofit for 125W Mercury		8800	7920	10000	6 7/8 (175)	4 5/16 (110)	1900	22		
ED28	E40	49941	LUH215/D/EZ/40	12	0	Diffuse, Energy-saving Retrofit for 250W Mercury		20200	18600	12000	9 1/8 (232)	5 7/32 (133)	1900	22		
MERCURY																
ED28	E40	32372	HR250DX37/40	12	0	Deluxe White		11200	8400	24000 +	8 3/8 (213)	5 5/32 (131)	3900	50		
ED37	E40	32294	HR400DX33/40	6	0	Deluxe White		22600	14400	24000	11 7/16 (291)	7 11/64 (182)	3900	50		
BT56	E40	12017	HR1000DX34/40	6	0	Deluxe White		58300	29200	16000	15 1/16 (383)	9 3/8 (238)	3900	50		

To save energy costs, find the bulbs with the light output you need, then choose the one with the lowest watts.
 (!) * All footnote references found at the end of this section. ➤ Reduced Wattage / High Color Rendering.

GENERAL INFORMATION**FIXTURE REQUIREMENTS**

HID lamps have fixture requirements that must be followed. The following three codes identify the appropriate fixture for a particular lamp. Lamps having an "O" code can be operated in an "Open or Enclosed" fixture. Lamps with a "V" code can be used in open fixtures only if operated in a vertical ± 15 degrees burn position. Lamps in all other burn positions must be suitably enclosed.

O = Open or Enclosed Fixtures

E = Enclosed Fixtures Only

V = Lamps operated in a vertical position (Base Up or Down), ± 15 degrees, can be used in an open fixture. Lamps burned in any other orientation must be used in "enclosed fixtures only".

Use in Enclosed Fixtures. "Enclosed" fixture means a fixture suitably enclosed and designed to contain fragments of hot quartz or glass (up to 1100° C) per UL Standard #1572 (if in doubt, contact your fixture manufacturer).

Use In Open Fixtures. For lamps operated in the vertical position $\pm 15^\circ$ that are not designated "Enclosed Fixtures Only," lamp may be used in an open or enclosed lighting fixture depending upon the application and operating environment. For example, if the lamp is located near combustible material or in an area which is unoccupied for extended periods, an enclosed fixture which can contain fragments of hot quartz or glass is recommended. For more information, contact your fixture manufacturer.

PROTECTION OF BULBS FROM MOISTURE

Outer bulbs of HID lamps are made of heat-resistant glass, designed to have strength and thermal-shock-resistant characteristics suitable for normal applications in typical luminaries. However, shielding of lamps must be provided to avoid bulb breakage that could result from direct contact with liquids (such as water) during operation.

RATED AVERAGE LIFE

Values are based on laboratory tests of a large number of representative lamps under controlled conditions, including operation at 10 hours per start on ballasts having specified electrical characteristics. Individual lamps or groups of lamps may, of course, vary from the Rated Average Life shown. Lamp operating conditions can also affect life. Where Rated Average Life is less than 24,000 hours, it is a MEDIAN value of life expectancy; that is, the total operating time at which, under normal operating conditions, 50% of any large group of initially installed lamps is expected to be still burning. Where Rated Average Life is 24,000+ hours, 67% of lamps are expected to be still burning at 24,000 hours. For cost-of-light calculations involving these lamps, if an estimated operating time is required at which 50% of the lamps will still be burning, a value of 28,500 hours is suggested. At burning cycles shorter than 10 hours per start, the median life will be shortened as follows:

5 hrs/start: approx. life 75% of rating

2½ hrs/start: approx. life 56% of rating

1¼ hrs/start: approx. life 42% of rating

LUMENS— LUMENS LISTED ARE REFERENCE LUMENS

Rated average lamp lumens are obtained under controlled laboratory conditions in a prescribed burning position. **Initial Reference Lumens** refer to the lamp lumen output after 100-hours burning. **Mean Reference Lumens** refer to the lamp lumen output at the mean lumen point during lamp life. The mean lumen point occurs at 50% rated life for HPS and mercury lamps, and at 40% rated life for metal halide lamps. Lamp performance on typical systems under typical service conditions will vary from the reference lumen ratings.

High Intensity Discharge lighting systems are subject to a wide range of variations which may affect final lighting levels. As a result, lamp performance on actual systems may vary due to lamp orientation, ambient temperatures, ballast variations, line voltage and other reasons. Care must be taken when choosing a system to consider how these changes can affect your light levels both initially and at the mean lumen point.

BALLASTS

HID lamps (except E-Z-Merc[®]) require auxiliary ballast equipment designed to produce proper electrical values. Actual lamp watts may vary depending on ballast characteristics. For total system watts, add nominal ballast watts.

All Lucalox[®], Mercury, and Metal Halide lamps (except I-Line) will start at ambient temperatures of -22°F (-30°C). I-Line Multi-Vapor[®] will start at ambient temperatures of 5°F (-15°C) when used on approved mercury ballasts.

START CHARACTERISTICS

Full light output does not occur immediately when power is applied. Instead, there is a time delay for the lamp to reach 90% total light output. The starting delay for High Pressure Sodium is 3-4 minutes, for Metal Halide 2-5 minutes, and for Mercury 5-7 minutes.

RESTART CHARACTERISTICS

With a power interruption of a half cycle or more, the arc will extinguish. When power is immediately reapplied, full light output does not occur immediately. For HPS lamps there is a delay of 1 minute to reach 90% total light output; however, Lucalox[®] LU1000 requires 2 minutes and E-Z Lux[®] lamps require 3 minutes to reach 90% total light output. For most Metal Halide lamps, including CMH[™], when the power is immediately reapplied, there will be a delay of 10 to 15 minutes before the lamps reach the 90% light output level. PulseArc[™] lamps restrike in <4 minutes. The restart delay for mercury lamps is 3 to 6 minutes to reach 90% total light output.

BURN POSITIONS AND CODES

Mercury and High Pressure Sodium lamps may be operated in any burn position and will still maintain their rated performance specifications. Metal Halide and Low Pressure Sodium lamps, however, are optimized for performance in specific burn positions, or may be restricted to certain burn positions for safety reasons.

U = Universal burning position

HBV = Horizontal -15° to Base Up

HBD = Horizontal +15° to Base Down

HOR = Horizontal $\pm 15^\circ$

VBU = Vertical Base Up $\pm 15^\circ$

VBD = Vertical Base Down $\pm 15^\circ$

If no special burn position is noted, the burn position is universal.

GENERAL INFORMATION (Continued)**HID COLOR**

The color temperature and CRI listed in the tabular data are for reference purposes only. All high intensity discharge lamps exhibit some degree of lamp to lamp color variation and shift over life. These characteristics can be increased based on choice of fixture, ballast, burning position, and ambient conditions. Color variation can be greater than normal during the initial 100 hours of burning. Where color consistency is important, consider using ConstantColor® CMH™ for better performance (page 3-8).

EXPORT BASE LAMPS (/27 AND /40)

Export only lamps have a non-domestic (non-U.S.) base and are not intended for use in the United States due to potential shock hazard. The lamps are identified by "/27" or "/40" at the end of the lamp description and comply with electrical characteristics defined by IEC standards.

OPERATING NOTES**E-Z LUX® LAMPS**

These high pressure sodium lamps should be operated only on certain mercury ballasts, as indicated below.

LUH110/EZ: use only with the following types of 125-watt mercury ballasts: high-reactance lag-type autotransformers or 220-volt or greater reactors.

LUH150/EZ: use only with the following types of H39 175-watt mercury ballasts: high-reactance lag-type autotransformers or 240-volt and 277-volt reactors. Do not use with CW (lead-type) or CWA ballasts.

LUH215/EZ: use only with the following types of H37 250-watt mercury ballasts: high reactance lag-type autotransformers or 240-volt and 277-volt reactors. Do not use with CW (lead-type) or CWA ballasts.

LUH360/EZ: use only with the following types of H33 400-watt mercury ballasts: high-reactance lag-type autotransformers, reactors, CWA auto regulators or CW regulators.

MXR32 METAL HALIDE LAMP AND ELECTRONIC BALLAST

MXR32 lamps must be operated on Lighting's special, high power factor electronic ballast, HAL32/120 (page 3-8). Outside dimensions for the ballast are 9¼" long, 3⅜" wide and 1¾" high.

SAF-T-GARD® MULTI-VAPOR® AND SAF-T-GARD® MERCURY LAMPS

Caution: If the outer glass envelope of a Saf-T-Gard® lamp is broken, the arc tube will self-extinguish, but the supporting structure will still be electrically connected. Be sure power is off and the lamp has cooled before removing the lamp to avoid possible electrical shock from contact with the arc tube support and to avoid risk of burn from the hot arc tube.

ARCSTREAM™ METAL HALIDE LAMPS

Arcstream™ tubular-shaped lamps must be used in suitably-enclosed fixtures with UV-absorbing cover glass. Enclosed fixtures must be capable of containing fragments of hot quartz or glass (up to 1100°C) in the unusual event of the outer bulb shattering. Also see complete Warning and Caution Notices on metal halide lamps.

WARNING NOTICES**THE FOLLOWING WARNING NOTICES MUST BE COMPLIED WITH TO HELP AVOID POSSIBLE LAMP RUPTURE.**

We will not be responsible for poor lamp performance, personal injury or property damage resulting from failure to follow these instructions.

HID LAMPS - GENERAL**WARNING**

Most HID lamps are constructed of an outer bulb with an internal arc tube made of quartz. The arc tube operates under high pressure at very high temperatures - as high as approximately 1100°C. The arc tube and outer bulb may unexpectedly rupture due to internal causes or external factors such as a system failure or misapplication.

An arc tube rupture can burst and shatter the outer glass bulb resulting in the discharge of glass fragments and extremely hot quartz particles (as high as 1100° C). There is a risk of personal injury, property damage, burns and fire.

Some lamps are position-sensitive and must only be operated in specified burning positions (see "Additional Information" column in this catalog) with compatible electrical equipment in the types of fixtures prescribed in "Fixture Requirements" on Page 3-21 of this catalog.

In addition to the general warnings above, there are specific warnings for the HID lamp types listed below.

Metal Halide Lamps

Fixture lens/diffuser material must be able to contain fragments of hot quartz or glass (up to 1100° C). If you do not know whether your fixture can safely withstand an arc tube rupture, contact your fixture manufacturer.

In continuously-operating systems (24 hours/day, 7 days/week), turn lamps off once per week for at least 15 minutes. FAILURE TO COMPLY INCREASES THE RISK OF RUPTURE.

Relamp fixtures at or before the end of rated life. Beyond rated life, light output diminishes while energy consumption and risk of rupture increase.

High Pressure Sodium Lamps

This is a vacuum jacket lamp and may implode if broken. As a precaution, wear safety glasses and gloves when installing or removing lamp. High pressure sodium lamps are not position-sensitive and may be operated in any burning position.

WARNING NOTICES (Continued)**Mercury Lamps**

Fixture lens/diffuser material must be able to contain fragments of hot quartz or glass (up to 1100° C). If you do not know whether your fixture can safely withstand an arc tube rupture, contact your fixture manufacturer.

Relamp fixtures at or before the end of rated life. Beyond rated life, light output diminishes while energy consumption and risk of rupture increase.

Mercury lamps are not position-sensitive and may be operated in any burning position.

Low Pressure Sodium Lamps

These lamps contain sodium which will ignite when exposed to water. If lamps are not disposed of properly, there is a risk of fire in the disposal vessel.

FIXTURES

Use in Enclosed Fixtures. "Enclosed" fixture means a fixture suitably enclosed and designed to contain fragments of hot quartz or glass (up to 1100°C) in accordance with UL Standard #1572 (if in doubt, contact your fixture manufacturer).

Use In Open Fixtures. For lamps operated in the vertical position $\pm 15^\circ$ that are not designated "Enclosed Fixtures Only," lamp may be used in an open or enclosed lighting fixture depending upon the application and operating environment. For example, if the lamp is located near combustible material or in an area which is unoccupied for extended periods, an enclosed fixture which can contain fragments of hot quartz or glass is recommended. For more information, contact your fixture manufacturer.

IMPORTANT NOTICE

In accordance with Federal Regulations (21 CFR 1040.30), the following notice applies to Multi-Vapor[®], Arcstream[™] PAR 64, ConstantColor[®] CMH[™] lamps, and all standard mercury lamps (those having Lamp Descriptions beginning with the letters "MVR...", "MXR...", "MB1150PAR64...", "CMH...", "HR...", or "HSB...").

"WARNING: This lamp can cause serious skin burn and eye inflammation from shortwave ultraviolet radiation if outer envelope of the lamp is broken or punctured, and the arc tube continues to operate. Do not use where people will remain for more than a few minutes unless adequate shielding or other safety precautions are used. Certain types of lamps that will automatically extinguish when the outer envelope is broken or punctured are commercially available from the Manufacturer. Self-extinguishing lamps include Saf-T-Gard[®] Mercury and Multi-Vapor[®] lamps."

FOOTNOTES**# Footnote**

- 9 Do not use this lamp in fixtures designed for less than rated lamp wattage.
- 13 For use only in 175-watt metal halide luminaires that do not exceed maximum temperatures of 160°C at the point where metallic base meets the heat resistant collar and 245°C on the solder button of the plastic collar for this lamp.
- 14 Life shown is for vertical $\pm 15^\circ$ operation.
- 16 Approximate lumen ratings at 45° burning position: Initial - 145,000. Mean - 108,000.
- 17 Rated life based on 5 or more burning hours per start.
- 28 Use only 1000-watt H12 or H34-type ballasts. Do not use on 1000-watt H36-type ballasts.
- 30 First life rating and mean lumen rating refers to operation @ 11 hrs. on / 1 hr. off cycle. Second life rating and mean lumen rating refer to operation @ 120 hrs. on / 1 hr. off cycle.
- 31 The CMH lamps shown can be operated on listed ballasts. When the alternate ballast is used, recommends that a label be placed on the fixture (where it can be read by a person replacing the lamp) that states: "Designed for use with a ceramic metal halide lamp only." A standard quartz-type metal halide lamp may not operate in the fixture.
- 32 Lamp will run at 400-watts when used on a linear reactor ballast.
- 33 Rated life based on 7 hours per start.
- 34 Approved ballast is ANSI M57 with add-on metal halide ignitor (3-4 Kv pulse, 1 micro second).
- 35 Approved ballast is ANSI M58 with add-on metal halide ignitor (3-4 Kv pulse, 1 micro second).
- 36 Approved ballasts are: ANSI M128; ANSI M59 with add-on metal halide ignitor (3-4 Kv pulse, 1 micro second); ANSI M135 with minimum open circuit voltage of 270-volts.
- 37 Approved ballasts are: ANSI M133; ANSI M48 with add-on metal halide ignitor (3-4 Kv pulse, 1 micro second).
- 38 Requires a non-ANSI designated ballast with a special, add-on metal halide ignitor. Contact your local Representative for a list of approved ballasts and ignitors.
- 39 UV Control is a new, quartz material that effectively cuts UVB and UVC radiation.
- 40 Approved ballasts are ANSI M135 or ANSI M59 with add-on metal halide ignitor (3-4Kv pulse, 1 micro second).