



**E12**



**E10**

**Catalog No. 61210**

Lamp socket adaptor from E12 to E10

Adaptor style is subject to change.

Dimensions in mm

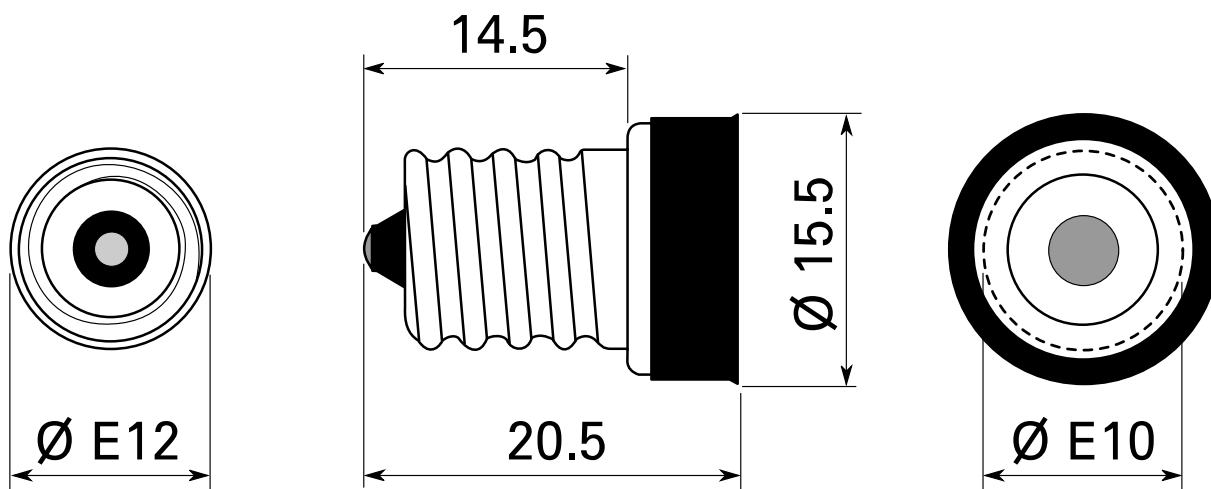

*Technical Data are Subject to Change without Notice. Dimensions in mm.*