

Wallplates

INDEX

Decora® Plus Screwless Snap-On	02, 04, 05
Decora®	03, 04, 05
Wallplate Overview	06
Toggle	07-09
Duplex Receptacle	10, 11
Single Receptacle	12
Telephone or Cable Outlet, Box Mount	13, 14
Telephone or Cable Outlet, Strap Mount	14, 15
Blank, Box Mount	16, 17
Blank, Strap Mount	17, 18
Power Outlet Receptacles	19, 20
Two-Gang with Centered Opening	21
Louvre Plates	22
CombinationWallplates	
Toggle and Single Receptacle	23
Toggle and Duplex Receptacle	23, 24
Toggle and Decora/GFCI	25
Toggle and Blank	26
Standard Combinations-2-Gang	26-28
Standard Combinations-3-Gang/4-Gang	28
Sectional for Multi-Gang Installations	29
Hot Stamped and Engraved	29, 30
Voice/Data/CATV	31
Weather Resistant Covers	
Raintight While-In-Use	32
Industrial Grade	33
Die-cast Zinc	34
Thermoplastic	35
Stainless Steel Lockout	34, 35
Accessories	36
Custom Wallplates	37-40



DECORA® PLUS SCREWLESS SNAP-ON WALLPLATES

Residential and Commercial Grade Wallplates

Decora Plus Screwless Snap-On Wallplates

- Sleek, smooth contemporary architectural styling enhances fine décor
- Exclusive new design eliminates subplate screws
- “Hook and Snap” subplate and wallplate mounting provides easy, time saving installation
- Decora-compatible two-piece kit allows easy retrofit to any Decora installation
- Tough, unbreakable polycarbonate construction
- Now available in standard and midway sizes that can be mounted onto larger-volume wallboxes and/or used to hide wall irregularities.



80301-SW
Standard Size



SJ26-SW
Midway Size

Standard Size Single-Gang Screwless Snap-On Wallplate

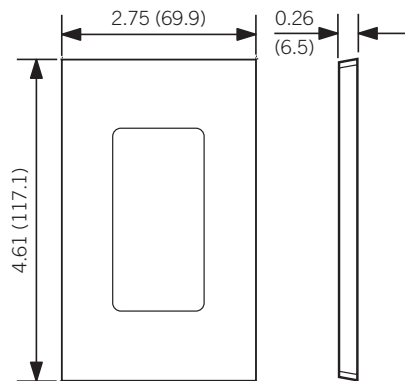

80301-S

Midway Size Single-Gang Screwless Snap-On Wallplate

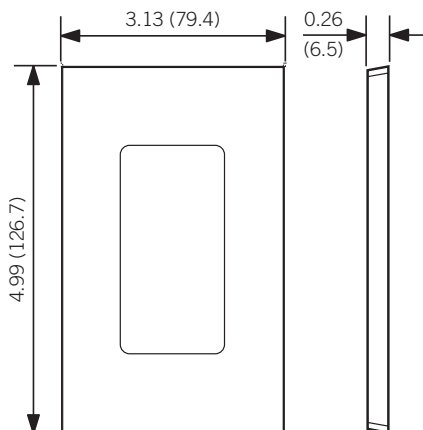

SJ26-S

Midway wallplates can be mounted onto larger-volume outlet boxes and/or used to hide wall irregularities. Midway wallplates are a full 0.375" higher and wider than standard size wallplates.

NOTE: Add 1.81" (46.0mm) for each additional gang.

Decora Plus Screwless Snap-On Wallplates

DESCRIPTION	COLOR	STANDARD	MIDWAY
1-Gang 1-Decora	Ivory	80301-SI	SJ26-SI
	Ebony/Black	80301-SE	SJ26-SE
	Gray	80301-SGY	SJ26-SGY
	White	80301-SW	SJ26-SW
	Mahogany/Brown	80301-S	SJ26-S
	Almond	80301-SA	SJ26-SA
	Light Almond	80301-ST	—
2-Gang 2-Decora	Ivory	80309-SI	SJ262-SI
	Ebony/Black	80309-SE	SJ262-SE
	Gray	80309-SGY	SJ262-SGY
	White	80309-SW	SJ262-SW
	Mahogany/Brown	80309-S	SJ262-S
	Almond	80309-SA	SJ262-SA
	Light Almond	80309-ST	—
3-Gang 3-Decora	Ivory	80311-SI	SJ263-SI
	Ebony/Black	80311-SE	SJ263-SE
	White	80311-SW	SJ263-SW
	Almond	80311-SA	SJ263-SA
	Light Almond	80311-ST	—
	—	—	—
4-Gang 4-Decora	Ivory	80312-SI	SJ264-SI
	White	80312-SW	SJ264-SW
	Almond	80312-SA	SJ264-SA
	Light Almond	80312-ST	—
	—	—	—
5-Gang 5-Decora	Ivory	80321-SI	SJ265-SI
	White	80321-SW	SJ265-SW
	Almond	80321-SA	SJ265-SA
	Light Almond	80321-ST	—
6-Gang 6-Decora	Ivory	80326-SI	SJ266-SI
	White	80326-SW	SJ266-SW
	Almond	80326-SA	SJ266-SA
	Light Almond	80326-ST	—

TESTING AND CODE COMPLIANCE

- UL Listed (File #E-13397)
- Meets NEMA Standards WD-1, WD-6
- CSA Certified (File #LR-16347)
- NOM Certified (File #057)
- Backed by a Limited Ten-Year Warranty

MATERIAL CHARACTERISTICS

Environmental: Flammability UL-94, V2 Rating
Operating Temperature: -40°C to 120°C

DECORA® WALLPLATES

Residential and Commercial Grade Decora Wallplates

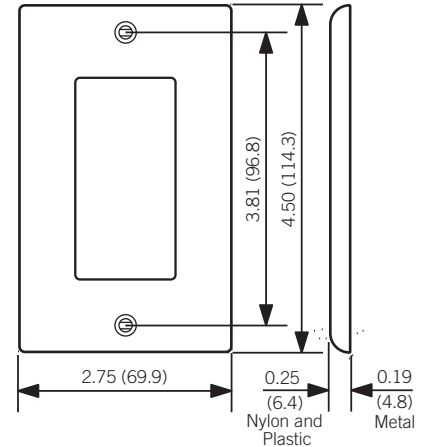

Standard Size Single-Gang

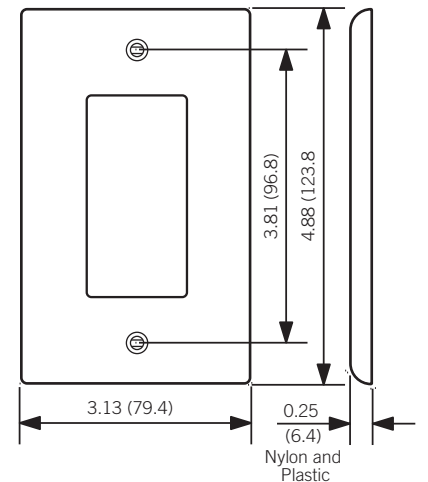

Midway Size Single-Gang

Midway wallplates can be mounted onto larger-volume outlet boxes and/or used to hide wall irregularities. Midway wallplates are a full 0.375" higher and wider than standard size wallplates.

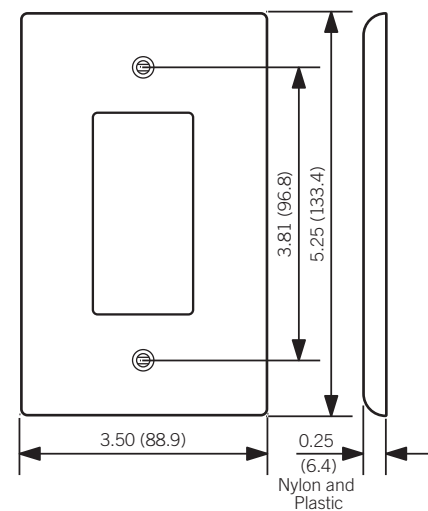

Oversized Single-Gang

Oversized wallplates are used to conceal greater wall irregularities than those hidden by Midway wallplates. Oversized wallplates are a full 0.75" higher and wider than standard size wallplates.

NOTE: Add 1.81" (46.0mm) for each additional gang.

All Decora Wallplates

- Accent any wall covering with a wide selection of colors and finishes
- Smooth face and rounded edges resist dust accumulation
- Individual plastic wrapping to protect wallplate's surface
- Color-matched metal mounting screws supplied

Residential Grade Thermoset Wallplates

- Photoelectrically color-matched to Decora devices
- Designed for high dielectric strength and arc resistance
- Meet or surpass UL 514 testing requirements
- Resistant to fading, discoloration, grease, oils, organic solvents and moisture scratches
- Backed by a Limited Two-Year Warranty

Commercial Grade Thermoplastic Wallplates

- Molded thermoplastic for maximum resistance to impact, abrasion, fading and discoloration
- Resistant to mechanical stress associated with high abuse applications
- Backed by a Limited Ten-Year Warranty

Commercial Grade Metal Wallplates

- Rounded edges to prevent injury and wall damage
- Deluxe stainless steel is non-magnetic Type 302, .032" thick
- Standard magnetic stainless steel Type 430, .032" thick, also available
- Brass is 70/30 alloy 260, .040" thick
- Aluminum is 3004 alloy, .040" thick
- Backed by a Limited Ten-Year Warranty

TESTING AND CODE COMPLIANCE

- Thermoplastic and Thermoset: UL Listed (File #E-13397)
- Metal: UL Listed (File #E-16347)
- Meets NEMA Standards WD-1, WD-6
- CSA Certified (File #LR-16347)
- NOM Certified (File #057)



MATERIAL CHARACTERISTICS

Environmental: Flammability UL-94, V2 Rating
Operating Temperature: -40°C to 120°C

WALLPLATES

Residential and Commercial Grade Decora Wallplates

Decora

	Thermoset			Thermoplastic		Screwless Snap-On Polycarbonate		Assorted Metals		
DESCRIPTION 1-Gang 1-Decora										
COLOR	STANDARD P26	MIDWAY SPJ26	OVERSIZE PO26	STANDARD N26	MIDWAY PJ26	STANDARD	MIDWAY	MATERIAL	STANDARD	OVERSIZE
Ivory	80401-I	80601-I	86601	80401-NI	PJ26-I	80301-SI	SJ26-SI	Chrome	*	—
Black	80401-E	—	—	80401-NE	PJ26-E	80301-SE	SJ26-SE	Aluminum	A26 83401	—
Gray	80401-GY	80601-GY	—	80401-NGY	PJ26-GY	80301-SGY	SJ26-SGY	Brass	B26 81401	—
White	80401-W	80601-W	88601	80401-NW	PJ26-W	80301-SW	SJ26-SW	Polished Brass	81401-PB	—
Brown	80401	80601	—	80401-N	PJ26	80301-S	SJ26-S	430 S/S	*	*
Almond	80401-A	80601-A	82601	80401-NA	PJ26-A	80301-SA	SJ26-SA	302 S/S	SN26-N 84401-40	SO26 SO26
Light Almond	80401-T	80601-T	—	80401-NT	PJ26-T	80301-ST	—			
Red	—	—	—	80401-NR	—	—	—			
Blue	—	—	—	80401-NB	PJ26-BU	—	—			
DESCRIPTION 2-Gang 2-Decora										
COLOR	STANDARD P262	MIDWAY SPJ262	OVERSIZE PO262	STANDARD N262	MIDWAY PJ262	STANDARD	MIDWAY	MATERIAL	STANDARD	OVERSIZE
Ivory	80409-I	80609-I	86602	80409-NI	PJ262-I	80309-SI	SJ262-SI	Chrome	*	—
Black	80409-E	—	—	80409-NE	PJ262-E	80309-SE	SJ262-SE	Aluminum	A262 83409	—
Gray	80409-GY	80609-GY	—	80409-NGY	PJ262-GY	80309-SGY	SJ262-SGY	Brass	B262 81409	—
White	80409-W	80609-W	88602	80409-NW	PJ262-W	80309-SW	SJ262-SW	Polished Brass	81409-PB	—
Brown	80409	80609	—	80409-N	PJ262	80309-S	SJ262-S	430 S/S	*	*
Almond	80409-A	80609-A	82602	80409-NA	PJ262-A	80309-SA	SJ262-SA	302 S/S	S262-N 84409-40	SO262 SO262
Light Almond	80409-T	80609-T	—	80409-NT	PJ262-T	80309-ST	—			
Red	—	—	—	80409-NR	PJ262-R	—	—			
Blue	—	—	—	80409-NB	—	—	—			
DESCRIPTION 3-Gang 3-Decora										
COLOR	STANDARD P263	MIDWAY SPJ263	OVERSIZE	STANDARD N263	MIDWAY PJ263	STANDARD	MIDWAY	MATERIAL	STANDARD	OVERSIZE
Ivory	80411-I	80611-I	—	80411-NI	PJ263-I	80311-SI	SJ263-SI	Chrome	*	—
Black	80411-E	—	—	—	—	80311-SE	SJ263-SE	Aluminum	A263 83411	—
Gray	80411-GY	—	—	80411-NGY	PJ263-GY	—	—	Brass	B263 81411	—
White	80411-W	80611-W	—	80411-NW	PJ263-W	80311-SW	SJ263-SW	Polished Brass	81411-PB	—
Brown	80411	—	—	80411-N	—	—	—	430 S/S	*	*
Almond	80411-A	80611-A	—	80411-NA	PJ263-A	80311-SA	SJ263-SA	302 S/S	S263-N 84411-40	SO263 SO263
Light Almond	80411-T	80611-T	—	80411-NT	PJ263-T	80311-ST	—			





*Consult our representative for ordering details: allow 3–4 weeks for delivery.

NOTE: Where applicable, Industry Number indicated in BOLD FACE. For some wallplates, Industry Number and Catalog Number are identical.

WALLPLATES

Residential and Commercial Grade Decora Wallplates

Decora

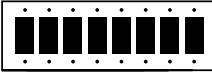
	Thermoset			Thermoplastic		Screwless Snap-On Polycarbonate		Assorted Metals		
DESCRIPTION 4-Gang 4-Decora										
COLOR	STANDARD P264	MIDWAY SPJ264	OVERSIZE	STANDARD N264	MIDWAY PJ264	STANDARD	MIDWAY	MATERIAL	STANDARD	OVERSIZE
Ivory	80412-I	80612-I	—	80412-NI	PJ264-I	80312-SI	SJ264-SI	Chrome	*	—
Black	80412-E	—	—	—	—	80312-SE	SJ264-SE	Brass	B264 81412	—
Gray	80412-GY	—	—	—	PJ264-GY	—	—	430 S/S	*	—
White	80412-W	80612-W	—	80412-NW	PJ264-W	80312-SW	SJ264-SW	302 S/S	S264-N 84412-40	—
Brown	80412	—	—	80412-N	—	—	—			
Almond	80412-A	80612-A	—	80412-NA	PJ264-A	80312-SA	SJ264-SA			
Light Almond	80412-T	80612-T	—	80412-NT	PJ264-T	80312-ST	—			
DESCRIPTION 5-Gang 5-Decora										
COLOR	STANDARD P265	MIDWAY	OVERSIZE	STANDARD N265	MIDWAY	STANDARD	MIDWAY	MATERIAL	STANDARD	OVERSIZE
Ivory	80423-I	—	—	80423-NI	—	80321-SI	SJ265-SI	Brass	B265 81423	—
Black	80423-E	—	—	—	—	—	—	430 S/S	*	—
Gray	80423-GY	—	—	—	—	—	—	302 S/S	S265 84423-40	—
White	80423-W	—	—	80423-NW	—	80321-SW	SJ265-SW			
Brown	80423	—	—	—	—	—	—			
Almond	80423-A	—	—	80423-NA	—	80321-SA	SJ265-SA			
Light Almond	80423-T	—	—	80423-NT	—	80321-ST	—			
DESCRIPTION 6-Gang 6-Decora										
COLOR	STANDARD P266	MIDWAY	OVERSIZE	STANDARD N266	MIDWAY	STANDARD	MIDWAY	MATERIAL	STANDARD	OVERSIZE
Ivory	80436-I	—	—	80436-NI	—	80326-SI	SJ266-SI	Brass	B266 *	—
Black	80436-E	—	—	—	—	—	—	430 S/S	—	—
Gray	80436-GY	—	—	—	—	—	—	302 S/S	S266-N 84436-40	—
White	80436-W	—	—	80436-NW	—	80326-SW	SJ266-SW			
Brown	80436	—	—	—	—	—	—			
Almond	80436-A	—	—	80436-NA	—	80326-SA	SJ266-SA			
Light Almond	80436-T	—	—	—	—	80326-ST	—			
DESCRIPTION 7-Gang 7-Decora										
COLOR	STANDARD S607	MIDWAY	OVERSIZE	STANDARD	MIDWAY	STANDARD	MIDWAY	MATERIAL	STANDARD	OVERSIZE
Ivory	80407-I†	—	—	—	—	—	—	Brass	B607 *	—
White	80407-W†	—	—	—	—	—	—	430 S/S	*	—
								302 S/S	S607-N *	—
DESCRIPTION 8-Gang 8-Decora										
COLOR	STANDARD S609	MIDWAY	OVERSIZE	STANDARD	MIDWAY	STANDARD	MIDWAY	MATERIAL	STANDARD	OVERSIZE
Ivory	80408-I†	—	—	—	—	—	—	Brass	B609 *	—
White	80408-W†	—	—	—	—	—	—	430 S/S	*	—
								302 S/S	S609-N *	—

*Consult our representative for ordering details: allow 3-4 weeks for delivery. †Painted metal

LARGER SIZE WALLPLATES

Residential and Commercial Grade Wallplates

A COMPLETE SELECTION OF WALLPLATES FOR INDUSTRIAL, COMMERCIAL AND RESIDENTIAL APPLICATIONS

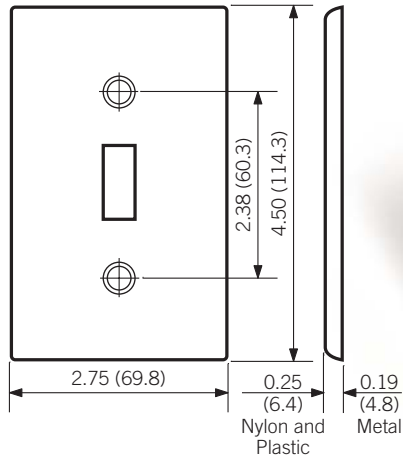

Standard Size Single-Gang

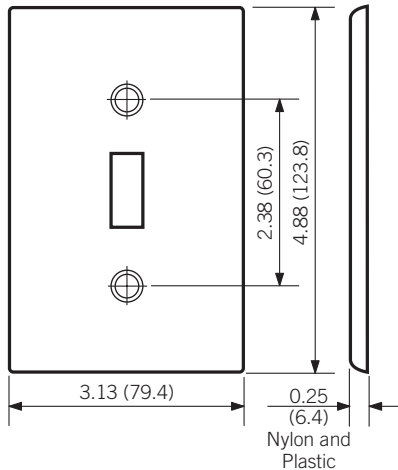

Midway Size Single-Gang

Midway wallplates can be mounted onto larger-volume outlet boxes and/or used to hide wall irregularities. Midway wallplates are a full 0.375" higher and wider than standard size wallplates.

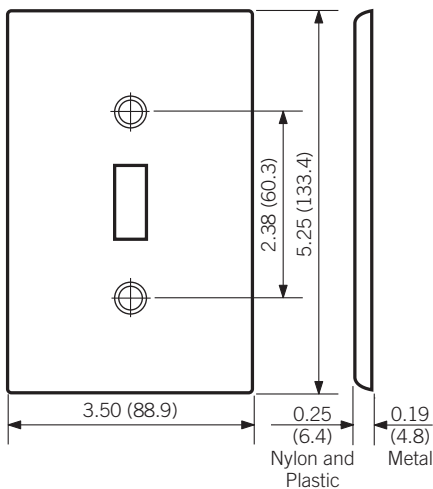

Oversized Single-Gang

Oversized wallplates are used to conceal greater wall irregularities than those hidden by Midway wallplates. Oversized wallplates are a full 0.75" higher and wider than standard size wallplates.

NOTE: Add 1.81" (46.0mm) for each additional gang.



Features and Benefits of All Wallplates

- Easy to Clean, smooth finish
- Noncombustible
- Individual plastic wrapping to protect wallplate surface
- Color-matched metal mounting screws supplied in an envelope to protect plate from scratches
- UL Listed and CSA Certified
- Conform to NEMA and ANSI Standards

Residential Grade Thermoset (Plastic) Wallplates

- Photoelectrically color-matched to Decora devices
- Designed for high dielectric strength and arc resistance
- Meet or surpass UL 514 testing requirements
- Resistant to fading, discoloration, grease, oils, organic solvents and moisture scratches
- Backed by a Limited Two-Year Warranty

Commercial Grade Thermoplastic (Nylon) Wallplates

- Molded thermoplastic for maximum resistance to impact, abrasion, fading and discoloration
- Resistant to mechanical stress associated with high abuse applications
- Backed by a Limited Ten-Year Warranty

Commercial Grade Metal Wallplates

- Rounded edges to prevent injury and wall damage
- Deluxe stainless steel is non-magnetic Type 302, .032" thick
- Standard magnetic stainless steel Type 430, .032" thick, also available
- Brass is 70/30 alloy 260, .040" thick
- Aluminum is 3004 alloy, .040" thick
- Backed by a Limited Ten-Year Warranty

TESTING AND CODE COMPLIANCE

- UL Listed
- Meets NEMA Standards WD-1, WD-6
- CSA Certified

MATERIAL CHARACTERISTICS

Environmental: Flammability UL-94, V2 Rating
Operating Temperature: -40°C to 120°C

WALLPLATES

Residential and Commercial Grade Wallplates

Toggle

	Thermoset (Plastic)			Thermoplastic (Nylon)		Assorted Metals		
--	---------------------	--	--	-----------------------	--	-----------------	--	--

DESCRIPTION 1-Gang 1-Toggle



COLOR	STANDARD P1	MIDWAY SPJ1	OVERSIZE PO1	STANDARD N1	MIDWAY PJ1	MATERIAL	STANDARD	OVERSIZE
Ivory	86001	80501-I	86101	80701-I	PJ1-I	Chrome	C1 1901	—
Black	—	—	—	80701-E	PJ1-E	Aluminum	A1 83001	—
Gray	87001	—	—	80701-GY	PJ1-GY	Brass	B1 81001	—
Red	—	—	—	80701-R	—	Polished Brass	81001-PB	—
White	88001	80501-W	88101	80701-W	PJ1-W	430 S/S	S1 84001	S01 84101
Brown	85001	80501	85101	80701	PJ1	302 S/S	S1-N 84001-40	S01-N 84101-40
Almond	82001	80501-A	—	80701-A	PJ1-A			
Light Almond	78001	80501-T	—	80701-T	PJ1-T			

DESCRIPTION 2-Gang 2-Toggles



COLOR	STANDARD P2	MIDWAY SPJ2	OVERSIZE PO2	STANDARD N2	MIDWAY PJ2	MATERIAL	STANDARD	OVERSIZE
Ivory	86009	80509-I	86109	80709-I	PJ2-I	Chrome	1909	—
Black	—	—	—	80709-E	PJ2-E	Aluminum	A2 83009	—
Gray	87009	—	—	80709-GY	PJ2-GY	Brass	B2 81009	—
Red	—	—	—	80709-R	—	Polished Brass	81009-PB	—
White	88009	80509-W	88109	80709-W	PJ2-W	430 S/S	S2 84009	—
Brown	85009	80509	85109	80709	PJ2	302 S/S	S2-N 84009-40	S02-N 84109-40
Almond	82009	80509-A	—	80709-A	PJ2-A			
Light Almond	78009	80509-T	—	80709-T	PJ2-T			

DESCRIPTION 3-Gang 3-Toggles

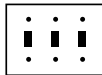

COLOR	STANDARD P3	MIDWAY SPJ3	OVERSIZE PO3	STANDARD N3	MIDWAY PJ3	MATERIAL	STANDARD	OVERSIZE
Ivory	86011	80511-I	86111	80711-I	PJ3-I	Chrome	*	—
Black	—	—	—	80711-E	PJ3-E	Aluminum	A3 83011	—
Gray	87011	—	—	80711-GY	PJ3-GY	Brass	B3 81011	—
Red	—	—	—	80711-R	—	Polished Brass	81011-PB	—
White	88011	80511-W	88111	80711-W	PJ3-W	430 S/S	S3 84011	—
Brown	85011	80511	85111	80711	PJ3	302 S/S	S3-N 84011-40	S03-N 84111-40
Almond	82011	80511-A	—	80711-A	PJ3-A			
Light Almond	78011	80511-T	—	80711-T	PJ3-T			

*Consult our representative for ordering details: allow 3-4 weeks for delivery.

NOTE: Where applicable, Industry Number indicated in BOLD FACE. For some wallplates, Industry Number and Catalog Number are identical.

WALLPLATES

Residential and Commercial Grade Wallplates

Toggle

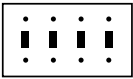
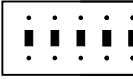
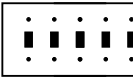
		Thermoset (Plastic)			Thermoplastic (Nylon)		Assorted Metals		
DESCRIPTION 4-Gang 4-Toggles									
COLOR	STANDARD P4	MIDWAY SPJ4	OVERSIZE	STANDARD N4	MIDWAY PJ4	MATERIAL	STANDARD	OVERSIZE	
Ivory	86012	80512-I	86101	80712-I	PJ4-I	Chrome	*	—	
Black	—	—	—	—	—	Aluminum	A4 83012	—	
Gray	87012	—	—	80712-GY	—	Brass	B4 81012	—	
Red	—	—	—	80712-R	—	Polished Brass	81012-PB	—	
White	88012	80512-W	—	80712-W	PJ4-W	430 S/S	S4 84012	*	
Brown	85012	—	—	—	—	302 S/S	S4-N 84012-40	S04-N 84112-40	
Almond	82012	80512-A	—	80712-A	PJ4-A				
Light Almond	78012	80512-T	—	80712-T	PJ4-T				
DESCRIPTION 5-Gang 5-Toggles									
COLOR	STANDARD P5	MIDWAY	OVERSIZE	STANDARD N5	MIDWAY	MATERIAL	STANDARD	OVERSIZE	
Ivory	86023	—	—	80723-I	—	Chrome	*	—	
White	88023	—	—	80723-W	—	Aluminum	A5 *	—	
Brown	85023	—	—	—	—	Brass	B5 81023	—	
Almond	82023	—	—	80723-A	—	Polished Brass	81023-PB	—	
Light Almond	78023	—	—	—	—	430 S/S	S5 *	—	
						302 S/S	S5-N 84023-40	—	
DESCRIPTION 6-Gang 6-Toggles									
COLOR	STANDARD P6	MIDWAY	OVERSIZE	STANDARD N6	MIDWAY	MATERIAL	STANDARD	OVERSIZE	
Ivory	86036	—	—	80736-I	—	Chrome	*	—	
White	88036	—	—	80736-W	—	Aluminum	A6 *	—	
Brown	85036	—	—	—	—	Brass	B6 81036	—	
Almond	82036	—	—	—	—	430 S/S	S6 *	—	
Light Almond	78036	—	—	—	—	302 S/S	S6-N 84036-40	—	

*Consult our representative for ordering details: allow 3–4 weeks for delivery.

NOTE: Where applicable, Industry Number indicated in **BOLD FACE**. For some wallplates, Industry Number and Catalog Number are identical.

WALLPLATES

Residential and Commercial Grade Wallplates

Toggle

DESCRIPTION 7-Gang 7-Toggles	Thermoset (Plastic)			Thermoplastic (Nylon)		Assorted Metals		
	STANDARD S601	MIDWAY	OVERSIZE	STANDARD	MIDWAY	MATERIAL	STANDARD	OVERSIZE
Ivory	S601-I†	—	—	—	—	Chrome	*	—
White	S601-W†	—	—	—	—	Brass	B601 *	—
						430 S/S	*	—
						302 S/S	S601-N 84070-40	—

†Painted metal wallplate.

DESCRIPTION 8-Gang 8-Toggles	Thermoset (Plastic)			Thermoplastic (Nylon)		Assorted Metals		
	STANDARD S602	MIDWAY	OVERSIZE	STANDARD N6	MIDWAY	MATERIAL	STANDARD	OVERSIZE
Ivory	S602-I†	—	—	80736-I	—	Chrome	*	—
White	S602-W†	—	—	80736-W	—	Brass	B602 *	—
						430 S/S	*	—
						302 S/S	S602-N 84048-40	—

†Painted metal wallplate.

DESCRIPTION 9-Gang 9-Toggles	Thermoset (Plastic)			Thermoplastic (Nylon)		Assorted Metals		
	STANDARD S603	MIDWAY	OVERSIZE	STANDARD	MIDWAY	MATERIAL	STANDARD	OVERSIZE
Ivory	S603-I†	—	—	—	—	Chrome	*	—
White	S603-W†	—	—	—	—	Brass	B603 *	—
						430 S/S	*	—
						302 S/S	S603-N 84049-40	—

†Painted metal wallplate.

DESCRIPTION 10-Gang 10-Toggles	Thermoset (Plastic)			Thermoplastic (Nylon)		Assorted Metals		
	STANDARD S604	MIDWAY	OVERSIZE	STANDARD	MIDWAY	MATERIAL	STANDARD	OVERSIZE
Ivory	S604-I†	—	—	—	—	Chrome	*	—
White	S604-W†	—	—	—	—	Brass	B604 *	—
						302 S/S	S604-N 84050-40	—

†Painted metal wallplate.



*Consult our representative for ordering details: allow 3–4 weeks for delivery.

NOTE: Where applicable, Industry Number indicated in BOLD FACE. For some wallplates, Industry Number and Catalog Number are identical.

WALLPLATES

Residential and Commercial Grade Wallplates

Receptacle

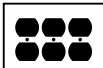
	Thermoset (Plastic)			Thermoplastic (Nylon)		Assorted Metals		
DESCRIPTION 1-Gang 1-Duplex								
COLOR	STANDARD P8	MIDWAY SPJ8	OVERSIZE	STANDARD N8	MIDWAY PJ8	MATERIAL	STANDARD	OVERSIZE
Ivory	86003	80503-I	86103	80703-I	PJ8-I	Chrome	C8 1903	—
Black	—	—	—	80703-E	PJ8-E	Aluminum	A8 83003	—
Gray	87003	—	—	80703-GY	PJ8-GY	Brass	B8 81003	—
Red	—	—	—	80703-R	PJ8-R	Polished Brass	81003-PB	—
White	88003	80503-W	88103	80703-W	PJ8-W	430 S/S	S8 84003	S08 84103
Brown	85003	80503	85103	80703	PJ8	302 S/S	S8-N 84003-40	S08-N 84103-40
Blue	—	—	—	80703-BU	PJ8-BU			
Almond	82003	80503-A	—	80703-A	PJ8-A			
Light Almond	78003	80503-T	—	80703-T	PJ8-T			
DESCRIPTION 2-Gang 2-Duplex								
COLOR	STANDARD P82	MIDWAY SPJ82	OVERSIZE	STANDARD N82	MIDWAY PJ82	MATERIAL	STANDARD	OVERSIZE
Ivory	86016	80516-I	86116	80716-I	PJ82-I	Chrome	C82 *	—
Black	—	—	—	80716-E	PJ82-E	Aluminum	A82 83016	—
Gray	87016	—	—	80716-GY	PJ82-GY	Brass	B82 81016	—
Red	—	—	—	80716-R	PJ82-R	Polished Brass	81016-PB	—
White	88016	80516-W	88116-W	80716-W	PJ82-W	430 S/S	S82 84016	S082
Brown	85016	80516	85116	80716	PJ82	302 S/S	S82-N 84016-40	S082-N 84116-40
Orange	—	—	—	80716-ORG	—			
Blue	—	—	—	80716-A	PJ82-BU			
Almond	82016	80516-A	—	80716-A	PJ82-A			
Light Almond	78016	80516-T	—	80716-T	PJ82-T			
DESCRIPTION 3-Gang 3-Duplex								
COLOR	STANDARD P83	MIDWAY	OVERSIZE	STANDARD	MIDWAY	MATERIAL	STANDARD	OVERSIZE
Ivory	86030	—	—	80730-I	—	Chrome	*	—
Black	—	—	—	80730-E	—	Aluminum	*	—
Gray	87030	—	—	80730-GY	—	Brass	*	—
Red	—	—	—	80730-R	—	430 S/S	S83 *	—
White	88030	—	—	80730-W	—	302 S/S	S83-N 84030-40	S083-N 84130-40
Brown	85030	—	—	80730	—			
Almond	—	—	—	80730-A	—			

*Consult our representative for ordering details: allow 3–4 weeks for delivery.

NOTE: Where applicable, Industry Number indicated in BOLD FACE. For some wallplates, Industry Number and Catalog Number are identical.

WALLPLATES

Residential and Commercial Grade Wallplates

Duplex Receptacle

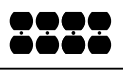
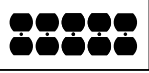
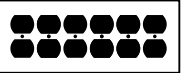
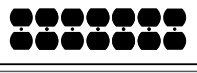
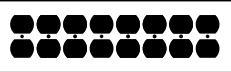
	Thermoset (Plastic)			Thermoplastic (Nylon)		Assorted Metals		
DESCRIPTION 4-Gang 4-Duplex								
COLOR	STANDARD	MIDWAY	OVERSIZE	STANDARD	MIDWAY	MATERIAL	STANDARD	OVERSIZE
	P84							
Ivory	86041	_____	_____	_____	_____	Chrome	*	_____
White	88041	_____	_____	_____	_____	Aluminum	*	_____
Brown	85041	_____	_____	_____	_____	Brass	*	_____
						430 S/S	S84 84041	*
						302 S/S	S84-N *	*
DESCRIPTION 5-Gang 5-Duplex								
COLOR	STANDARD	MIDWAY	OVERSIZE	STANDARD	MIDWAY	MATERIAL	STANDARD	OVERSIZE
						Chrome	*	_____
						Brass	B85 *	_____
						302 S/S	S85-N 84055-40	_____
DESCRIPTION 6-Gang 6-Duplex								
COLOR	STANDARD	MIDWAY	OVERSIZE	STANDARD	MIDWAY	MATERIAL	STANDARD	OVERSIZE
						Chrome	*	_____
						Brass	B86 *	_____
						302 S/S	S86-N 84056-40	_____
DESCRIPTION 7-Gang 7-Duplex								
COLOR	STANDARD	MIDWAY	OVERSIZE	STANDARD	MIDWAY	MATERIAL	STANDARD	OVERSIZE
						Chrome	*	_____
						Brass	B608 *	_____
						430 S/S	S608 *	_____
						302 S/S	*	_____
DESCRIPTION 8-Gang 8-Duplex								
COLOR	STANDARD	MIDWAY	OVERSIZE	STANDARD	MIDWAY	MATERIAL	STANDARD	OVERSIZE
						Chrome	*	_____
						Brass	B6082 *	_____
						430 S/S	S6082 *	_____
						302 S/S	*	_____

*Consult our representative for ordering details: allow 3-4 weeks for delivery.

NOTE: Where applicable, Industry Number indicated in BOLD FACE. For some wallplates, Industry Number and Catalog Number are identical.

WALLPLATES

Residential and Commercial Grade Wallplates

Single Receptacle—15 Amp and 20 Amp Straight Blade and 15 Amp Locking
Thermoset (Plastic) **Thermoplastic (Nylon)**

Assorted Metals

DESCRIPTION

1-Gang
1-Single 1.406" dia. Hole



COLOR	STANDARD P7	MIDWAY SPJ7	OVERSIZE	STANDARD N7	MIDWAY PJ7	MATERIAL	STANDARD	OVERSIZE
Ivory	86004	80504-I	—	80704-I	PJ7-I	Chrome	*	—
Black	—	—	—	80704-E	PJ7-E	Aluminum	A7 83004	—
Gray	87004	—	—	80704-GY	PJ7-GY	Brass	B7 81004	—
Red	—	—	—	80704-R	PJ7-R	430 S/S	S7 84004	*
White	88004	80504-W	—	80704-W	PJ7-W	302 S/S	S7-N 84004-40	S07-N 84104-40
Brown	85004	80504	—	80704	PJ7			
Orange	—	—	—	80704-ORG	—			
Almond	82004	80504-A	—	80704-A	PJ7-A			
Light Almond	78004	80504-T	—	80704-T	PJ7-T			

DESCRIPTION

2-Gang
2-Singles 1.406" dia. Holes



COLOR	STANDARD P72	MIDWAY SPJ82	OVERSIZE	STANDARD N82	MIDWAY PJ82	MATERIAL	STANDARD	OVERSIZE
Ivory	86052	—	—	—	—	Chrome	*	—
White	88052	—	—	—	—	Aluminum	*	—
Brown	85052	—	—	—	—	Brass	*	—
						430 S/S	S72 *	—
						302 S/S	S72-N 84052-40	—

DESCRIPTION

3-Gang
3-Singles 1.406" dia. Holes

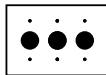

COLOR	STANDARD	MIDWAY	OVERSIZE	STANDARD	MIDWAY	MATERIAL	STANDARD	OVERSIZE
						Brass	*	—
						430 S/S	S73 *	—
						302 S/S	S73-N S73-N	—

DESCRIPTION

4-Gang
4-Singles 1.406" dia. Holes

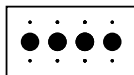

COLOR	STANDARD	MIDWAY	OVERSIZE	STANDARD	MIDWAY	MATERIAL	STANDARD	OVERSIZE
						Brass	*	—
						430 S/S	S74 *	—
						302 S/S	S74-N	—

DESCRIPTION

5-Gang
5-Singles 1.406" dia. Holes

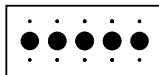

COLOR	STANDARD	MIDWAY	OVERSIZE	STANDARD	MIDWAY	MATERIAL	STANDARD	OVERSIZE
						Brass	*	—
						430 S/S	S75 *	—
						302 S/S	S75-N	—

DESCRIPTION

6-Gang
6-Singles 1.406" dia. Holes

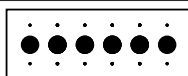

COLOR	STANDARD	MIDWAY	OVERSIZE	STANDARD	MIDWAY	MATERIAL	STANDARD	OVERSIZE
						Brass	*	—
						430 S/S	S76 *	—
						302 S/S	S76-N	—





*Consult our representative for ordering details: allow 3-4 weeks for delivery.

NOTE: Where applicable, Industry Number indicated in BOLD FACE. For some wallplates, Industry Number and Catalog Number are identical.

WALLPLATES

Residential and Commercial Grade Wallplates

Telephone or Cable Outlet Wallplates—Box Mounted

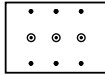
Thermoset (Plastic)			Thermoplastic (Nylon)			Assorted Metals		
DESCRIPTION 1-Gang Phone/Cable .312" dia. Hole, Box Mount 								
COLOR	STANDARD	MIDWAY SPJ738	OVERSIZE	STANDARD	MIDWAY	MATERIAL	STANDARD	OVERSIZE
Ivory	—	80513-I	—	—	—	Aluminum	A738 83013	—
White	—	80513-W	—	—	—	Brass	B738 81013	—
Brown	—	80513	—	—	—	430 S/S	S738 84013	—
Almond	—	80513-A	—	—	—	302 S/S	S7-N 84013-40	—
Light Almond	—	80513-T	—	—	—			
DESCRIPTION 1-Gang Phone/Cable .406" dia. Hole, Box Mount 								
COLOR	STANDARD P11	MIDWAY	OVERSIZE	STANDARD	MIDWAY PJ11	MATERIAL	STANDARD	OVERSIZE
Ivory	86013	—	—	—	PJ11-I	Aluminum	*	—
Black	—	—	—	—	PJ11-E	Brass	*	—
Gray	—	—	—	—	PJ11-GY	430 S/S	*	—
White	88013	—	—	—	PJ11-W	302 S/S	S11-N 84061-40	*
Brown	85013	—	—	—	—			
Almond	82013	—	—	—	PJ11-A			
Light Almond	78013	—	—	—	PJ11-T			
DESCRIPTION 1-Gang Phone/Cable .625" dia. Hole, Box Mount 								
COLOR	STANDARD P737	MIDWAY	OVERSIZE	STANDARD	MIDWAY	MATERIAL	STANDARD	OVERSIZE
Ivory	86017	—	—	—	—	Aluminum	A737 *	—
White	88017	—	—	—	—	Brass	B737 81017	—
Brown	85017	—	—	—	—	430 S/S	S737 *	—
						302 S/S	S737-N 84017-40	—
DESCRIPTION 2-Gang Phone/Cable .406" dia. Hole, Box Mount 								
COLOR	STANDARD P21	MIDWAY	OVERSIZE	STANDARD	MIDWAY	MATERIAL	STANDARD	OVERSIZE
Ivory	86062	—	—	—	—	Brass	*	—
White	88062	—	—	—	—	430 S/S	*	—
Brown	85062	—	—	—	—	302 S/S	S21-N 84062-40	—
DESCRIPTION 3-Gang Phone/Cable .406" dia. Hole, Box Mount 								
COLOR	STANDARD	MIDWAY	OVERSIZE	STANDARD	MIDWAY	MATERIAL	STANDARD	OVERSIZE
						Brass	*	—
						430 S/S	*	—
						302 S/S	S31-N	—

*Consult our representative for ordering details: allow 3-4 weeks for delivery.

NOTE: Where applicable, Industry Number indicated in BOLD FACE. For some wallplates, Industry Number and Catalog Number are identical.

WALLPLATES

Residential and Commercial Grade Wallplates

Telephone or Cable Outlet Wallplates—Box Mounted

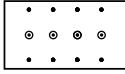
Thermoset (Plastic)			Thermoplastic (Nylon)			Assorted Metals		
DESCRIPTION 4-Gang Phone/Cable .406" dia. Hole, Box Mount 								
COLOR	STANDARD	MIDWAY	OVERSIZE	STANDARD	MIDWAY	MATERIAL	STANDARD	OVERSIZE
						Brass	*	_____
						430 S/S	*	_____
						302 S/S	\$41-N *	_____

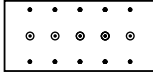
DESCRIPTION 5-Gang Phone/Cable .406" dia. Hole, Box Mount 								
COLOR	STANDARD	MIDWAY	OVERSIZE	STANDARD	MIDWAY	MATERIAL	STANDARD	OVERSIZE
						Brass	*	_____
						430 S/S	*	_____
						302 S/S	\$51-N *	_____

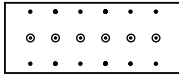
DESCRIPTION 6-Gang Phone/Cable .406" dia. Hole, Box Mount 								
COLOR	STANDARD	MIDWAY	OVERSIZE	STANDARD	MIDWAY	MATERIAL	STANDARD	OVERSIZE
						Brass	*	_____
						430 S/S	*	_____
						302 S/S	\$61-N *	_____

Telephone or Cable Outlet Wallplates—Strap Mounted

Thermoset (Plastic)			Thermoplastic (Nylon)			Assorted Metals		
DESCRIPTION 1-Gang Phone/Cable .406" dia. Hole, Strap Mount With knockout to enlarge hole to .625" 								
COLOR	STANDARD P12	MIDWAY	OVERSIZE	STANDARD	MIDWAY	MATERIAL	STANDARD	OVERSIZE
Ivory	86018	_____	_____	_____	_____	Aluminum	*	_____
Gray	87018	_____	_____	_____	_____	Brass	*	_____
White	88018	_____	_____	_____	_____	430 S/S	\$12 *	_____
Brown	85018	_____	_____	_____	_____	302 S/S	\$12-N 84018-40	_____

DESCRIPTION 1-Gang Phone/Cable .406" dia. Hole, Strap Mount 								
COLOR	STANDARD	MIDWAY	OVERSIZE PO12	STANDARD N12	MIDWAY	MATERIAL	STANDARD	OVERSIZE
Ivory	_____	_____	86113	80718-I	_____	Brass	*	_____
White	_____	_____	88113	80718-W	_____	430 S/S	*	_____
Black	_____	_____	_____	80718-E	_____	302 S/S	*	_____
Gray	_____	_____	_____	80718-GY	_____			
Brown	_____	_____	_____	80718	_____			

DESCRIPTION 1-Gang Phone/Cable .625" dia. Hole, Strap Mount 								
COLOR	STANDARD P730	MIDWAY	OVERSIZE	STANDARD	MIDWAY	MATERIAL	STANDARD	OVERSIZE
Ivory	86037	_____	_____	_____	_____	Brass	*	_____
White	88037	_____	_____	_____	_____	430 S/S	*	S0730 84137
Brown	85037	_____	_____	_____	_____	302 S/S	S730-N 84037-40	S0730-N 84137-40

*Consult our representative for ordering details: allow 3-4 weeks for delivery.

NOTE: Where applicable, Industry Number indicated in BOLD FACE. For some wallplates, Industry Number and Catalog Number are identical.

WALLPLATES

Residential and Commercial Grade Wallplates

Telephone or Cable Outlet Wallplates—Strap Mounted

Thermoset (Plastic)			Thermoplastic (Nylon)			Assorted Metals		
DESCRIPTION 2-Gang Phone/Cable .406" dia. Hole, Strap Mount 								
COLOR	STANDARD	MIDWAY	OVERSIZE	STANDARD	MIDWAY	MATERIAL	STANDARD	OVERSIZE
Ivory	P22-1†	—	—	—	—	Brass	—	—
						430 S/S	*	—
						302 S/S	\$22-N	*

†Painted metal wallplate.

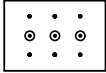
DESCRIPTION 3-Gang Phone/Cable .406" dia. Hole, Strap Mount 								
COLOR	STANDARD	MIDWAY	OVERSIZE	STANDARD	MIDWAY	MATERIAL	STANDARD	OVERSIZE
Ivory	P32-1†	—	—	—	—	Brass	—	—
						430 S/S	*	—
						302 S/S	\$32-N	*

†Painted metal wallplate.

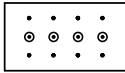
DESCRIPTION 4-Gang Phone/Cable .406" dia. Hole, Strap Mount 								
COLOR	STANDARD	MIDWAY	OVERSIZE	STANDARD	MIDWAY	MATERIAL	STANDARD	OVERSIZE
						Brass	*	—
						430 S/S	*	—
						302 S/S	\$42-N	*

†Painted metal wallplate.

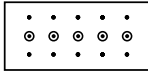
DESCRIPTION 5-Gang Phone/Cable .406" dia. Hole, Strap Mount 								
COLOR	STANDARD	MIDWAY	OVERSIZE	STANDARD	MIDWAY	MATERIAL	STANDARD	OVERSIZE
						Brass	*	—
						430 S/S	*	—
						302 S/S	\$52-N	*

†Painted metal wallplate.

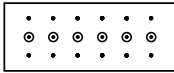
DESCRIPTION 6-Gang Phone/Cable .406" dia. Hole, Strap Mount 								
COLOR	STANDARD	MIDWAY	OVERSIZE	STANDARD	MIDWAY	MATERIAL	STANDARD	OVERSIZE
						Brass	*	—
						430 S/S	*	—
						302 S/S	\$62-N	*

†Painted metal wallplate.



*Consult our representative for ordering details: allow 3–4 weeks for delivery.

NOTE: Where applicable, Industry Number indicated in BOLD FACE. For some wallplates, Industry Number and Catalog Number are identical.

WALLPLATES

Residential and Commercial Grade Wallplates

Blank Wallplates—Box Mounted

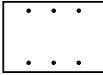
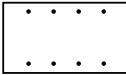
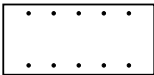
Thermoset (Plastic)				Thermoplastic (Nylon)		Assorted Metals		
DESCRIPTION 1-Gang 1-Blank, Box Mounted								
								
COLOR	STANDARD P13	MIDWAY SPJ13	OVERSIZE P013	STANDARD N13	MIDWAY PJ13	MATERIAL	STANDARD	OVERSIZE
Ivory	86014	80514-I	86114	80714-I	PJ13-I	Chrome	*	—
Black	—	—	—	80714-E	PJ13-E	Aluminum	A13 83014	—
Gray	87014	—	—	80714-GY	PJ13-GY	Brass	B13 81014	—
Red	—	—	—	80714-R	PJ13-R	430 S/S	S13 84014	S013 84114
White	88014	80514-W	88114	80714-W	PJ13-W	302 S/S	S13-N 84014-40	S013-N 84114-40
Brown	85014	80514	85114	80714	PJ13			
Almond	82014	80514-A	—	80714-A	PJ13-A			
Light Almond	78014	80514-T	—	80714-T	PJ13-T			
DESCRIPTION 2-Gang 2-Blanks, Box Mounted								
								
COLOR	STANDARD P23	MIDWAY SPJ23	OVERSIZE	STANDARD N24	MIDWAY	MATERIAL	STANDARD	OVERSIZE
Ivory	86025	80525-I	—	80725-I	PJ23-I	Aluminum	*	—
Black	—	—	—	80725-E	—	Brass	B23 81025	—
Gray	87025	—	—	80725-GY	PJ23-GY	430 S/S	S23 84025	—
White	88025	80525-W	—	80725-W	PJ23-W	302 S/S	S23-N 84025-40	S023-N 84125-40
Brown	85025	80525	—	80725	—			
Almond	82025	80525-A	—	80725-A	PJ23-A			
Light Almond	78025	80525-T	—	80725-T	PJ23-T			
DESCRIPTION 3-Gang 3-Blanks, Box Mounted								
								
COLOR	STANDARD P33	MIDWAY	OVERSIZE	STANDARD	MIDWAY	MATERIAL	STANDARD	OVERSIZE
Ivory	86033	—	—	80735-I	—	Aluminum	*	—
White	88033	—	—	80735-W	—	Brass	*	—
Brown	85033	—	—	80735	—	430 S/S	*	—
Black	—	—	—	80735-E	—	302 S/S	S33-N 84033-40	S033-N 84133-40
Gray	—	—	—	80735-GY	—			
Almond	—	—	—	80735-A	—			
DESCRIPTION 4-Gang 4-Blanks, Box Mounted								
								
COLOR	STANDARD P43	MIDWAY	OVERSIZE	STANDARD	MIDWAY	MATERIAL	STANDARD	OVERSIZE
Ivory	86064	—	—	—	—	Aluminum	*	—
White	88064	—	—	—	—	Brass	*	—
Brown	85064	—	—	—	—	430 S/S	S43 84064	*
						302 S/S	S43-N 84064-40	*
DESCRIPTION 5-Gang 5-Blanks, Box Mounted								
								
COLOR	STANDARD	MIDWAY	OVERSIZE	STANDARD	MIDWAY	MATERIAL	STANDARD	OVERSIZE
						Brass	*	—
						302 S/S	S53-N 84065-40	—

*Consult our representative for ordering details: allow 3–4 weeks for delivery.

NOTE: Where applicable, Industry Number indicated in **BOLD FACE**. For some wallplates, Industry Number and Catalog Number are identical.



WALLPLATES

Residential and Commercial Grade Wallplates

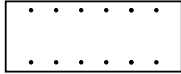
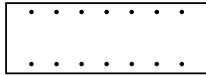
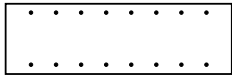
Blank Wallplates—Box Mounted

Thermoset (Plastic)				Thermoplastic (Nylon)		Assorted Metals		
DESCRIPTION 6-Gang 6-Blanks, Box Mounted								
COLOR	STANDARD	MIDWAY	OVERSIZE	STANDARD	MIDWAY	MATERIAL	STANDARD	OVERSIZE
						Brass	*	_____
						302 S/S	S63-N 84066-40	_____
DESCRIPTION 7-Gang 7-Blanks, Box Mounted								
COLOR	STANDARD	MIDWAY	OVERSIZE	STANDARD	MIDWAY	MATERIAL	STANDARD	OVERSIZE
						Brass	*	_____
						302 S/S	S6013-N 84067-40	_____
DESCRIPTION 8-Gang 8-Blanks, Box Mounted								
COLOR	STANDARD	MIDWAY	OVERSIZE	STANDARD	MIDWAY	MATERIAL	STANDARD	OVERSIZE
						Brass	*	_____
						302 S/S	S6023-N 84068-40	_____

Blank Wallplates—Strap Mounted

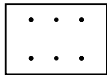
Thermoset (Plastic)				Thermoplastic (Nylon)		Assorted Metals		
DESCRIPTION 1-Gang 1-Blank, Strap Mounted								
COLOR	STANDARD P12	MIDWAY	OVERSIZE	STANDARD	MIDWAY	MATERIAL	STANDARD	OVERSIZE
Ivory	86019	_____	_____	80719-I	_____	Aluminum	*	_____
Black	_____	_____	_____	80719-E	_____	Brass	*	_____
Gray	_____	_____	_____	80719-GY	_____	430 S/S	S14 84019	*
Red	_____	_____	_____	80719-R	_____	302 S/S	S14-N 84019-40	S014-N 84119-40
White	88019	_____	_____	80719-W	_____			
Brown	85019	_____	_____	80719	_____			
Almond	_____	_____	_____	80719-A	_____			
DESCRIPTION 2-Gang 2-Blank, Strap Mounted								
COLOR	STANDARD P24	MIDWAY	OVERSIZE	STANDARD	MIDWAY	MATERIAL	STANDARD	OVERSIZE
Ivory	86034	_____	_____	80734-I	_____	430 S/S	*	_____
White	88034	_____	_____	80734-W	_____	302 S/S	S24-N 84034-40	S024-N 84134-40
Brown	85034	_____	_____	80734	_____			
Black	_____	_____	_____	80734-E	_____			
Red	_____	_____	_____	80734-R	_____			
DESCRIPTION 3-Gang 3-Blank, Strap Mounted								
COLOR	STANDARD P34	MIDWAY	OVERSIZE	STANDARD	MIDWAY	MATERIAL	STANDARD	OVERSIZE
Ivory	86035	_____	_____	_____	_____	Brass	*	_____
White	88035	_____	_____	_____	_____	430 S/S	*	*
Brown	85035	_____	_____	_____	_____	302 S/S	S34-N 84035-40	_____

*Consult our representative for ordering details: allow 3-4 weeks for delivery.

NOTE: Where applicable, Industry Number indicated in BOLD FACE. For some wallplates, Industry Number and Catalog Number are identical.

WALLPLATES

Residential and Commercial Grade Wallplates

Blank Wallplates—Strap Mounted

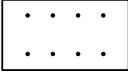
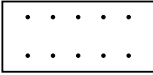
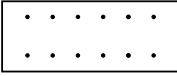
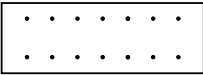
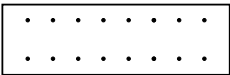
Thermoset			Thermoplastic			Assorted Metals		
DESCRIPTION 4-Gang 4-Blank, Strap Mounted 								
COLOR	STANDARD	MIDWAY	OVERSIZE	STANDARD	MIDWAY	MATERIAL	STANDARD	OVERSIZE
Ivory	86057	—	—	—	—	Brass	*	—
White	88057	—	—	—	—	430 S/S	*	*
Brown	85057	—	—	—	—	302 S/S	S44-N 84057-40	—
DESCRIPTION 5-Gang 5-Blank, Strap Mounted 								
COLOR	STANDARD	MIDWAY	OVERSIZE	STANDARD	MIDWAY	MATERIAL	STANDARD	OVERSIZE
						Brass	*	—
						430 S/S	*	—
						302 S/S	S54-N S54-N	—
DESCRIPTION 6-Gang 6-Blank, Strap Mounted 								
COLOR	STANDARD	MIDWAY	OVERSIZE	STANDARD	MIDWAY	MATERIAL	STANDARD	OVERSIZE
						Brass	*	—
						430 S/S	*	—
						302 S/S	S64-N *	—
DESCRIPTION 7-Gang 7-Blank, Strap Mounted 								
COLOR	STANDARD	MIDWAY	OVERSIZE	STANDARD	MIDWAY	MATERIAL	STANDARD	OVERSIZE
						Brass	*	—
						430 S/S	*	—
						302 S/S	S6014-N *	—
DESCRIPTION 8-Gang 8-Blank, Strap Mounted 								
COLOR	STANDARD	MIDWAY	OVERSIZE	STANDARD	MIDWAY	MATERIAL	STANDARD	OVERSIZE
						Brass	*	—
						430 S/S	*	—
						302 S/S	S6024-N *	—

*Consult our representative for ordering details: allow 3–4 weeks for delivery.

NOTE: Where applicable, Industry Number indicated in BOLD FACE. For some wallplates, Industry Number and Catalog Number are identical.

WALLPLATES

Residential and Commercial Grade Wallplates

Power Outlet Receptacle – One Gang
Thermoset (Plastic)

Thermoplastic (Nylon)

Assorted Metals

DESCRIPTION

20A & 30A Locking Receptacles
1-Gang 1.60" dia. Hole



COLOR	STANDARD	MIDWAY	OVERSIZE	STANDARD N726	MIDWAY	MATERIAL	STANDARD	OVERSIZE
Ivory	_____	_____	_____	80720-I	_____	Brass	*	_____
Black	_____	_____	_____	80720-E	_____	430 S/S	*	_____
Gray	_____	_____	_____	80720-GY	_____	302 S/S	S720-N 84020-40	_____
Red	_____	_____	_____	80720-R	_____			
White	_____	_____	_____	80720-W	_____			
Brown	_____	_____	_____	80720	_____			

DESCRIPTION

30A & 50A Power Receptacle
1-Gang 2.15" dia. Hole
Use with 278, 279, 5206, 5207, 5371, 5372, 5373, 5374



COLOR	STANDARD	MIDWAY P724	OVERSIZE	STANDARD	MIDWAY N724	MATERIAL	STANDARD	OVERSIZE
Ivory	_____	80528-I	_____	_____	80728-I	Aluminum	A724 83028	_____
Black	_____	80528-BLK	_____	_____	80728-E	Steel, Brass Finish	B724 4928	_____
Gray	_____	_____	_____	_____	80728-GY	Steel, Aluminum Finish	S724-GY 4927	_____
White	_____	80528-W	_____	_____	80728-W	430 S/S	S724 84028	_____
Brown	_____	_____	_____	_____	80728			

DESCRIPTION

30A & 50A Power Receptacle
1-Gang 2.465" dia. Hole



COLOR	STANDARD	MIDWAY	OVERSIZE	STANDARD	MIDWAY	MATERIAL	STANDARD	OVERSIZE
Ivory	_____	_____	_____	_____	80532-I			
White	_____	_____	_____	_____	80532-W			
Black	_____	_____	_____	_____	80532-E			

Power Outlet Receptacle—Two Gang
Thermoset (Plastic)

Thermoplastic (Nylon)

Assorted Metals

DESCRIPTION

30A & 50A Power Receptacle
2-Gang 2.15" dia. Hole
For use with 278,279, 5206, 5207, 5371, 5372, 5373, 5374



COLOR	STANDARD	MIDWAY PJ 703	OVERSIZE	STANDARD	MIDWAY N703	MATERIAL	STANDARD	OVERSIZE
Ivory	_____	80526-I	_____	_____	80726-I	Brass	B703 *	_____
Black	_____	80526-BLK	_____	_____	_____	Alum	A703 83026	_____
White	_____	80526-W	_____	_____	80726-W	Steel,Alum Fin.	S703-GY 4934	_____
Brown	_____	_____	_____	_____	80726	430 S/S	S703 84026	_____

*Consult our representative for ordering details: allow 3–4 weeks for delivery.

NOTE: Where applicable, Industry Number indicated in BOLD FACE. For some wallplates, Industry Number and Catalog Number are identical.

WALLPLATES

Residential and Commercial Grade Wallplates

Power Outlet Receptacle – Two Gang

Thermoset (Plastic)			Thermoplastic (Nylon)			Assorted Metals		
DESCRIPTION 2-Gang 2.15" dia. Hole Offset 								
COLOR	STANDARD	MIDWAY	OVERSIZE	STANDARD	MIDWAY	MATERIAL	STANDARD	OVERSIZE
						430 S/S	S705 84022	—

DESCRIPTION 30A & 50A Power Receptacle 2-Gang 2.465" dia. Hole 								
COLOR	STANDARD	MIDWAY	OVERSIZE	STANDARD	MIDWAY	MATERIAL	STANDARD	OVERSIZE
Ivory	—	80530-I	—	—	—	Steel, Alum Fin	S701-GY S701-GY	—
Black	—	80530-BLK	—	—	—	430 S/S	S701 *	—
White	—	80530-W	—	—	—	302 S/S	S701-40	—
Gray	—	—	—	—	—			
Almond	—	80530-A	—	—	—			
Light Almond	—	80530-T	—	—	—			









*Consult our representative for ordering details: allow 3–4 weeks for delivery.

NOTE: Where applicable, Industry Number indicated in BOLD FACE. For some wallplates, Industry Number and Catalog Number are identical.

WALLPLATES

Residential and Commercial Grade Wallplates

Two Gang with Centered Opening

Thermoset (Plastic)				Thermoplastic (Nylon)		Assorted Metals				
DESCRIPTION 2-Gang 1-Toggle							MATERIAL	STANDARD	OVERSIZE	
								Brass	81040	_____
								430 S/S	_____	_____
								302 S/S	S740-N 84040-40	_____
COLOR	STANDARD	MIDWAY	OVERSIZE	STANDARD	MIDWAY					
DESCRIPTION 2-Gang 1-Phone/Cable .406" Hole, Box Mount							MATERIAL	STANDARD	OVERSIZE	
								Brass	*	_____
								430 S/S	*	_____
								302 S/S	*	_____
COLOR	STANDARD	MIDWAY	OVERSIZE	STANDARD	MIDWAY					
DESCRIPTION 2-Gang 1-Phone/Cable .406" Hole, Strap Mount							MATERIAL	STANDARD	OVERSIZE	
								Brass	*	_____
								430 S/S	*	_____
								302 S/S	*	_____
COLOR	STANDARD	MIDWAY	OVERSIZE	STANDARD	MIDWAY					
DESCRIPTION 2-Gang Blank Box Mount							MATERIAL	STANDARD	OVERSIZE	
								Brass	*	_____
								430 S/S	*	_____
								302 S/S	*	_____
COLOR	STANDARD	MIDWAY	OVERSIZE	STANDARD	MIDWAY					
DESCRIPTION 2-Gang Blank Strap Mount							MATERIAL	STANDARD	OVERSIZE	
								Brass	_____	_____
								430 S/S	_____	_____
								302 S/S	*	_____
COLOR	STANDARD	MIDWAY	OVERSIZE	STANDARD	MIDWAY					
DESCRIPTION 2-Gang 1-Decora							MATERIAL	STANDARD	OVERSIZE	
								Brass	_____	_____
								430 S/S	*	_____
								302 S/S	S746-N S746-N	_____
COLOR	STANDARD	MIDWAY	OVERSIZE	STANDARD	MIDWAY					
DESCRIPTION 2-Gang 1 Single Outlet 1.406" dia. Hole							MATERIAL	STANDARD	OVERSIZE	
								Brass	_____	_____
								430 S/S	*	_____
								302 S/S	S747-N 84092-40	_____
COLOR	STANDARD	MIDWAY	OVERSIZE	STANDARD	MIDWAY					
DESCRIPTION 2-Gang 1-Duplex							MATERIAL	STANDARD	OVERSIZE	
								302 S/S	S748-N 84039-40	_____
COLOR	STANDARD	MIDWAY	OVERSIZE	STANDARD	MIDWAY					

*Consult our representative for ordering details: allow 3-4 weeks for delivery.

NOTE: Where applicable, Industry Number indicated in BOLD FACE. For some wallplates, Industry Number and Catalog Number are identical.

WALLPLATES

Residential and Commercial Grade Wallplates

Louvre Plates

	Thermoset (Plastic)			Thermoplastic (Nylon)		Assorted Metals		
--	---------------------	--	--	-----------------------	--	-----------------	--	--

DESCRIPTION
1-Gang Center
1-Louvre Plate
Horizontal Box Mount



COLOR	STANDARD P760	MIDWAY	OVERSIZE	STANDARD	MIDWAY	MATERIAL	STANDARD	OVERSIZE
Ivory	86079†	—	—	—	—	Brass	B760 81079	—
White	88079†	—	—	—	—	430 S/S	*	—
						302 S/S	S760-N 84079-40	—

DESCRIPTION
1-Gang
1-Louvre Plate
Strap Mount



COLOR	STANDARD P771	MIDWAY	OVERSIZE	STANDARD	MIDWAY	MATERIAL	STANDARD	OVERSIZE
Ivory	86080†	—	—	—	—	Brass	B771 81080	—
White	88080†	—	—	—	—	430 S/S	*	—
						302 S/S	S771-N 84080-40	—

DESCRIPTION
2-Gang
2-Louvre Plate
Strap Mount



COLOR	STANDARD	MIDWAY	OVERSIZE	STANDARD	MIDWAY	MATERIAL	STANDARD	OVERSIZE
						Brass	*	—
						430 S/S	*	—
						302 S/S	S772-N 84081-40	—

DESCRIPTION
3-Gang
3-Louvre Plate
Strap Mount



COLOR	STANDARD	MIDWAY	OVERSIZE	STANDARD	MIDWAY	MATERIAL	STANDARD	OVERSIZE
						Brass	*	—
						430 S/S	*	—
						302 S/S	*	—

†Painted metal wallplate.

*Consult our representative for ordering details: allow 3–4 weeks for delivery.

NOTE: Where applicable, Industry Number indicated in **BOLD FACE**. For some wallplates, Industry Number and Catalog Number are identical.

WALLPLATES

Residential and Commercial Grade Wallplates

Combination Wallplates Toggle Switch and Single Receptacle

Thermoset (Plastic)			Thermoplastic (Nylon)			Assorted Metals		
DESCRIPTION 2-Gang 1-Toggle 1-Single 1.406" dia. Hole 								
COLOR	STANDARD	MIDWAY	OVERSIZE	STANDARD	MIDWAY	MATERIAL	STANDARD	OVERSIZE
	P17							
Ivory	86007	—	—	—	—	Aluminum	*	—
White	88007	—	—	—	—	Brass	*	—
Brown	85007	—	—	—	—	430 S/S	S17 84007	—
						302 S/S	S17-N 84007-40	—

DESCRIPTION 3-Gang 2-Toggles 1-Single 1.406" dia. Hole 								
COLOR	STANDARD	MIDWAY	OVERSIZE	STANDARD	MIDWAY	MATERIAL	STANDARD	OVERSIZE
						Aluminum	*	—
						Brass	*	—
						430 S/S	*	—
						302 S/S	S27-N 84088-40	—

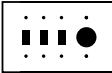
DESCRIPTION 4-Gang 3-Toggles 1-Single 1.406" dia. Hole 								
COLOR	STANDARD	MIDWAY	OVERSIZE	STANDARD	MIDWAY	MATERIAL	STANDARD	OVERSIZE
						Aluminum	*	—
						Brass	*	—
						430 S/S	*	—
						302 S/S	S37-N 84042-40	—

Combination Wallplates Toggle Switch and Duplex Receptacle

Thermoset (Plastic)			Thermoplastic (Nylon)			Assorted Metals		
DESCRIPTION 2-Gang 1-Toggle 1-Duplex 								
COLOR	STANDARD	MIDWAY	OVERSIZE	STANDARD	MIDWAY	MATERIAL	STANDARD	OVERSIZE
	P18	SPJ18	P018	N18				
Ivory	86005	80505-I	86105	80705-I	PJ18-I	Aluminum	A18 83005	—
Black	—	—	—	80705-E	PJ18-E	Brass	B18 81005	—
Gray	87005	—	—	80705-GY	PJ18-GY	430 S/S	S18 84005	*
Red	—	—	—	80705-R	—	302 S/S	S18-N 84005-40	S018-N 84105-40
White	88005	80505-W	88105	80705-W	PJ18-W			
Brown	85005	80505	85105	80705	—			
Almond	82005	80505-A	—	80705-A	PJ18-A			
Light Almond	78005	80505-T	—	80705-T	PJ18-T			

*Consult our representative for ordering details: allow 3-4 weeks for delivery.

NOTE: Where applicable, Industry Number indicated in BOLD FACE. For some wallplates, Industry Number and Catalog Number are identical.

WALLPLATES

Residential and Commercial Grade Wallplates

Combination Wallplates Toggle Switch and Duplex Receptacle

	Thermoset (Plastic)			Thermoplastic (Nylon)		Assorted Metals		
--	---------------------	--	--	-----------------------	--	-----------------	--	--

DESCRIPTION 3-Gang 2-Toggles 1-Duplex



COLOR	STANDARD P28	MIDWAY SPJ28	OVERSIZE	STANDARD N28	MIDWAY	MATERIAL	STANDARD	OVERSIZE
Ivory	86021	80521-I	—	80721-I	—	Aluminum	*	—
Black	—	—	—	80721-E	—	Brass	B28 81021	—
Gray	87021	—	—	—	—	430 S/S	*	*
White	88021	80521-W	—	80721-W	—	302 S/S	S28-N 84021-40	S028-N 84121-40
Brown	85021	80521	—	—	—			
Almond	82021	80521-A	—	—	—			
Light Almond	78021	80521-T	—	—	—			

DESCRIPTION 4-Gang 3-Toggles 1-Duplex

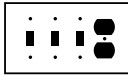

COLOR	STANDARD P38	MIDWAY	OVERSIZE	STANDARD	MIDWAY	MATERIAL	STANDARD	OVERSIZE
Ivory	P38-I	—	—	80743-I	—	Aluminum	*	—
White	P38-W	—	—	80743-W	—	Brass	*	—
Brown	P38	—	—	—	—	430 S/S	84043	*
Almond	P38-A	—	—	—	—	302 S/S	*	—
Light Almond	P38-T	—	—	—	—			

DESCRIPTION 5-Gang 4-Toggles 1-Duplex

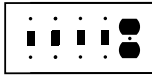

COLOR	STANDARD P48	MIDWAY	OVERSIZE	STANDARD	MIDWAY	MATERIAL	STANDARD	OVERSIZE
Ivory	P48-I	—	—	—	—	Brass	*	—
White	P48-W	—	—	—	—	430 S/S	*	—
						302 S/S	S48-N S48-N	—

*Consult our representative for ordering details: allow 3-4 weeks for delivery.

NOTE: Where applicable, Industry Number indicated in BOLD FACE. For some wallplates, Industry Number and Catalog Number are identical.

WALLPLATES

Residential and Commercial Grade Wallplates

Combination Wallplates Toggle Switch and Decora/GFCI

	Thermoset (Plastic)	Thermoplastic (Nylon)	Assorted Metals
--	---------------------	-----------------------	-----------------

DESCRIPTION

2-Gang 1-Toggle 1-Decora/GFCI



COLOR	STANDARD P126	MIDWAY SPJ126	OVERSIZE P0126	STANDARD	MIDWAY PJ126	MATERIAL	STANDARD	OVERSIZE
Ivory	80405-I	80605-I	86605	80707-I	PJ126-I	Brass	*	—
Black	80405-E	—	—	80707-E	—	430 S/S	S126 S126	—
Gray	80405-GY	—	—	80707-GY	—	302 S/S	*	—
Red	—	—	—	80707-R	—			
White	80405-W	80605-W	88605	80707-W	PJ126-W			
Brown	80405	80605	—	80707	PJ126			
Almond	80405-A	80605-A	82605	80707-A	PJ126-A			
Light Almond	80405-T	80605-T	—	80707-T	PJ126-T			

DESCRIPTION

3-Gang 2-Toggles 1-Decora/GFCI



COLOR	STANDARD P226	MIDWAY SPJ226	OVERSIZE	STANDARD	MIDWAY SPJ226	MATERIAL	STANDARD	OVERSIZE
Ivory	80421-I	—	—	80745-I	PJ226-I	Brass	*	—
Black	80421-E	—	—	—	—	430 S/S	*	—
White	80421-W	—	—	80745-W	PJ226-W	302 S/S	S226-N 84421-40	—
Brown	80421	—	—	—	PJ226			
Almond	80421-A	—	—	80745-A	PJ226-A			
Light Almond	80421-T	—	—	—	PJ226-T			

DESCRIPTION

3-Gang 2-Decora/GFCI 1 - Toggle



COLOR	STANDARD P1262	MIDWAY	OVERSIZE	STANDARD	MIDWAY	MATERIAL	STANDARD	OVERSIZE
Ivory	80431-I	—	—	80731-I	—	Brass	*	—
Black	—	—	—	80731-E	—	430 S/S	*	—
Gray	80431-GY	—	—	80731-GY	—	302 S/S	*	—
White	80431-W	—	—	80731-W	—			
Brown	80431	—	—	—	—			
Almond	80431-A	—	—	—	—			
Light Almond	80431-T	—	—	—	—			

DESCRIPTION

4-Gang 2-Toggles 2-Decora/GFCI



COLOR	STANDARD P326	MIDWAY	OVERSIZE	STANDARD	MIDWAY	MATERIAL	STANDARD	OVERSIZE
Ivory	P326-I	—	—	80732-I	—	Brass	*	—
White	P326-W	—	—	80732-W	—	430 S/S	*	—
Brown	P326	—	—	—	—	302 S/S	*	—
Almond	P326-A	—	—	—	—			
Light Almond	P326-T	—	—	—	—			

DESCRIPTION

4-Gang 3-Toggles 1-Decora/GFCI



COLOR	STANDARD P2262	MIDWAY	OVERSIZE	STANDARD	MIDWAY SPJ826	MATERIAL	STANDARD	OVERSIZE
Ivory	P2262-I†	—	—	—	—	Brass	*	—
White	P2262-W†	—	—	—	—	430 S/S	*	—
						302 S/S	*	—

DESCRIPTION

5-Gang 4-Toggles 1-Decora/GFCI



COLOR	STANDARD	MIDWAY	OVERSIZE	STANDARD	MIDWAY SPJ826	MATERIAL	STANDARD	OVERSIZE
						Brass	*	—
						430 S/S	*	—
						302 S/S	S426-N S426-N	—

†Painted metal wallplate.

*Consult our representative for ordering details: allow 3–4 weeks for delivery.

WALLPLATES

Residential and Commercial Grade Wallplates

Combination Wallplates

Toggle Switch and Blank—Box Mount and Strap Mount

Thermoset (Plastic)				Thermoplastic (Nylon)		Assorted Metals		
DESCRIPTION 2-Gang 1-Toggle 1-Blank, Strap Mount 								
COLOR	STANDARD	MIDWAY	OVERSIZE	STANDARD	MIDWAY	MATERIAL	STANDARD	OVERSIZE
Ivory	_____	_____	_____	80706-I	_____	Aluminum	*	_____
Black	_____	_____	_____	80706-E	_____	Brass	*	_____
Gray	_____	_____	_____	80706-GY	_____	430 S/S	*	_____
Red	_____	_____	_____	80706-R	_____	302 S/S	S114-N 84077-40	_____
White	_____	_____	_____	80706-W	_____			
Brown	_____	_____	_____	80706	_____			
Almond	_____	_____	_____	80706-A	_____			
Light Almond	_____	_____	_____	80706-T	_____			

DESCRIPTION

3-Gang
2-Toggles 1-Blank, Strap Mount

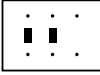

COLOR	STANDARD	MIDWAY	OVERSIZE	STANDARD	MIDWAY	MATERIAL	STANDARD	OVERSIZE
						Brass	*	_____
						430 S/S	*	_____
						302 S/S	S214-N S214-N	_____

DESCRIPTION

2-Gang
1-Toggle 1-Blank, Box Mount



COLOR	STANDARD P113	MIDWAY SPJ113	OVERSIZE P0113	STANDARD	MIDWAY	MATERIAL	STANDARD	OVERSIZE
Ivory	86006	80506-I	86106	_____	_____	Brass	*	_____
Gray	87006	_____	_____	_____	_____	430 S/S	*	_____
White	88006	80506-W	88106	_____	_____	302 S/S	S113-N 84006-40	_____
Brown	85006	80506	85106	_____	_____			

Combination Wallplates

Standard Combinations—Two Gang

Thermoset (Plastic)				Thermoplastic (Nylon)		Assorted Metals		
DESCRIPTION 2-Gang 1-Single 1.406" dia. hole 1-Duplex 								
COLOR	STANDARD P78	MIDWAY	OVERSIZE	STANDARD	MIDWAY	MATERIAL	STANDARD	OVERSIZE
Ivory	86046†	_____	_____	_____	_____	Aluminum	*	_____
White	88046†	_____	_____	_____	_____	Brass	*	_____
						430 S/S	*	*
						302 S/S	S78-N 84046-40	S078-N 84146-40

†Painted metal wallplate.

*Consult our representative for ordering details: allow 3–4 weeks for delivery.

NOTE: Where applicable, Industry Number indicated in BOLD FACE. For some wallplates, Industry Number and Catalog Number are identical.

WALLPLATES

Residential and Commercial Grade Wallplates

Combination Wallplates Standard Combinations—Two Gang Thermoset (Plastic)

Thermoplastic (Nylon)

Assorted Metals

DESCRIPTION

2-Gang
1-Duplex 1-Decora/GFCI



COLOR	STANDARD P826	MIDWAY	OVERSIZE	STANDARD	MIDWAY PJ826	MATERIAL	STANDARD	OVERSIZE
Ivory	80455-I	—	—	80746-I	PJ826-I	Aluminum	*	—
Black	—	—	—	80746-E	—	Brass	*	—
Gray	—	—	—	80746-GY	—	430 S/S	*	—
Red	—	—	—	80746-R	—	302 S/S	S826-N 84455-40	—
White	80455-W	—	—	80746-W	PJ826-W			
Brown	80455	—	—	80746	PJ826			
Almond	80455-A	—	—	80746-A	PJ826-A			
Light Almond	80455-T	—	—	80746-T	PJ826-T			

DESCRIPTION

2-Gang
1-Toggle 1-Phone/Cable .406" dia. hole, Strap Mount



COLOR	STANDARD P112	MIDWAY	OVERSIZE	STANDARD	MIDWAY	MATERIAL	STANDARD	OVERSIZE
Ivory	86077	—	—	—	—	Brass	*	—
White	88077	—	—	—	—	430 S/S	*	—
						302 S/S	S112-N S112-N	—

DESCRIPTION

2-Gang
1-Phone/Cable .406" dia. hole, Strap Mount 1 – Duplex



COLOR	STANDARD	MIDWAY	OVERSIZE	STANDARD	MIDWAY	MATERIAL	STANDARD	OVERSIZE
Ivory	86078	—	—	—	—	Brass	*	—
White	88078	—	—	—	—	430 S/S	*	—
						302 S/S	S128-N 84078-40	—

DESCRIPTION

2-Gang
1-Phone/Cable .406" dia. hole 1 – Blank, Strap Mount



COLOR	STANDARD	MIDWAY	OVERSIZE	STANDARD	MIDWAY	MATERIAL	STANDARD	OVERSIZE
						Brass	*	—
						430 S/S	*	—
						302 S/S	*	—

DESCRIPTION

2-Gang
1-Phone/Cable .406" dia. hole 1 – Blank, Strap Mount



COLOR	STANDARD P1226	MIDWAY	OVERSIZE	STANDARD	MIDWAY	MATERIAL	STANDARD	OVERSIZE
Ivory	80479-I	—	—	—	—	Brass	*	—
White	80479-W	—	—	—	—	430 S/S	*	—
						302 S/S	*	—

DESCRIPTION

2-Gang
1-Blank 1- Duplex, Box Mount



COLOR	STANDARD P138	MIDWAY SPJ138	OVERSIZE PO138	STANDARD N138	MIDWAY	MATERIAL	STANDARD	OVERSIZE
Ivory	86008	80508-I	86108	N138-I	—	Brass	*	—
White	88008	80508-W	—	N138-W	—	430 S/S	*	—
Brown	85008	80508	85108	—	—	302 S/S	S138-N 84008-40	—

*Consult our representative for ordering details: allow 3–4 weeks for delivery.

NOTE: Where applicable, Industry Number indicated in BOLD FACE. For some wallplates, Industry Number and Catalog Number are identical.

WALLPLATES

Residential and Commercial Grade Wallplates

Combination Wallplates Standard Combinations—Two Gang Thermoset (Plastic)

DESCRIPTION
2-Gang
1-Blank 1- Duplex, Strap Mount



COLOR	Thermoset (Plastic)			Thermoplastic (Nylon)		Assorted Metals		
	STANDARD P148	MIDWAY	OVERSIZE	STANDARD PJ826	MIDWAY	MATERIAL	STANDARD	OVERSIZE
Ivory	86087†	—	—	—	—	Brass	*	—
White	88087†	—	—	—	—	430 S/S	*	—
						302 S/S	S148-N 84087-40	—

DESCRIPTION
2-Gang
1-Blank 1-Single 1.406" dia. hole, Strap Mount



COLOR	Thermoset (Plastic)			Thermoplastic (Nylon)		Assorted Metals		
	STANDARD P147-I	MIDWAY	OVERSIZE	STANDARD	MIDWAY	MATERIAL	STANDARD	OVERSIZE
Ivory	86085†	—	—	—	—	Aluminum	*	—
White	88085†	—	—	—	—	Brass	*	—
						430 S/S	*	—
						302 S/S	S147-N 84085-40	—

DESCRIPTION
2-Gang
1-Blank 1-Decora/GFCI, Strap Mount



COLOR	Thermoset (Plastic)			Thermoplastic (Nylon)		Assorted Metals		
	STANDARD P1426	MIDWAY SPJ1326	OVERSIZE	STANDARD	MIDWAY	MATERIAL	STANDARD	OVERSIZE
Ivory	P1426-I†	80608-I	—	80708-I	—	Brass	*	—
Black	—	—	—	80708-E	—	430 S/S	*	*
Gray	—	—	—	80708-GY	—	302 S/S	S1426-N S1426-N	*
Red	—	—	—	80708-R	—			
White	P1426-W†	80608-W	—	80708-W	—			
Brown	—	80608	—	80708	—			
Almond	—	80608-A	—	80708-A	—			
Light Almond	—	80608-T	—	80708-T	—			

STANDARD COMBINATIONS—THREE GANG

DESCRIPTION
3-Gang
1-Toggle 2-Duplex



COLOR	Thermoset (Plastic)			Thermoplastic (Nylon)		Assorted Metals		
	STANDARD P182	MIDWAY	OVERSIZE	STANDARD	MIDWAY	MATERIAL	STANDARD	OVERSIZE
Ivory	86047	—	—	80747-I	—	Brass	*	—
White	88047	—	—	80747-W	—	430 S/S	*	*
Brown	85047	—	—	—	—	302 S/S	S182-N 84047-40	S0182-N 84147-40

STANDARD COMBINATIONS—FOUR GANG

DESCRIPTION
4-Gang
2-Toggle 2-Duplex

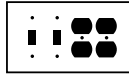

COLOR	Thermoset (Plastic)			Thermoplastic (Nylon)		Assorted Metals		
	STANDARD P1226	MIDWAY	OVERSIZE	STANDARD	MIDWAY	MATERIAL	STANDARD	OVERSIZE
						Aluminum	*	—
						Brass	B282 81045	—
						430 S/S	*	—
						302 S/S	S282-N 84045-40	—

†Painted metal wallplate.

*Consult our representative for ordering details: allow 3–4 weeks for delivery.

NOTE: Where applicable, Industry Number indicated in BOLD FACE. For some wallplates, Industry Number and Catalog Number are identical.

ENGRAVED WALLPLATES

Residential and Commercial Grade Wallplates

Sectional Wallplates for Multi-Gang Installations†
Thermoplastic Construction

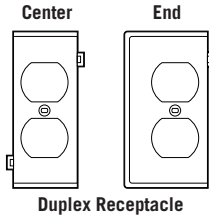

DESCRIPTION	COLOR	CENTER PANELS CAT. NO.	END PANELS CAT. NO.
Duplex Receptacle	White Ivory Red	PSC 8-W PSC 8-I PSC8-R	PSE 8-W PSE 8-I PSE8-R
Toggle Switch	White Ivory	PSC 1-W PSC 1-I	PSE 1-W PSE 1-I
Single Receptacle, 1.406" dia. hole	White Ivory Red	PSC 7-W PSC 7-I PSC7-R	PSE 7-W PSE 7-I PSE7-R
Blank, Strap-Mount	White Ivory	PSC 14 PSC14-I	PSE 14-W PSE 14-I
Decora	White Ivory	PSC 26-W PSC 26-I	PSE 26-W PSE 26-I

† Outer dimensions of wallplates created from two or more sectional panels will be the same as standard multi-gang plates.

Horizontal Split Plate for Terminated Cable

DESCRIPTION
Horizontal Split Plate for Terminated Cable
1-Gang .625" dia. Hole w/Grommet .406" inner dia.



COLOR	CAT. NO.	IND. NO.	METAL	CAT. NO.	IND. NO.
Ivory	N751-I	N751-I	BRASS	*	_____
White	N751-W	N751-W	430 S/S	*	_____
			302 S/S	S751-N	S751-N

Hot Stamped And Engraved Plates

Thermoset (Plastic)	Thermoplastic (Nylon)	Assorted Metals (Engraved)
---------------------	-----------------------	----------------------------

DESCRIPTION

1-Gang 1-Duplex
Stamped And Engraved
"EMERGENCY"



COLOR	STANDARD	MIDWAY	OVERSIZE	STANDARD	MIDWAY	MATERIAL	STANDARD	OVERSIZE
Red	_____	_____	_____	80703-RE	PJ8-RE	302 S/S	84003-E40	_____

2-Gang 2-Duplex
Stamped And Engraved
"EMERGENCY"



COLOR	STANDARD	MIDWAY	OVERSIZE	STANDARD	MIDWAY	MATERIAL	STANDARD	OVERSIZE
Red	_____	_____	_____	80716-RE	PJ82-RE	302 S/S	84016-E40	_____

1-Gang 1-Duplex
Stamped And Engraved
"ISOLATED GROUND"



COLOR	STANDARD	MIDWAY	OVERSIZE	STANDARD	MIDWAY	MATERIAL	STANDARD	OVERSIZE
Orange	_____	_____	_____	80703-IG	PJ8-IG	302 S/S	84003-IG	_____
Ivory	_____	_____	_____	80703-IGI	_____			
White	_____	_____	_____	80703-IGW	_____			

2-Gang 2-Duplex
Stamped And Engraved
"ISOLATED GROUND"



COLOR	STANDARD	MIDWAY	OVERSIZE	STANDARD	MIDWAY	MATERIAL	STANDARD	OVERSIZE
Orange	_____	_____	_____	80716-IG	_____	302 S/S	*	_____

1-Gang 1-Single, 1.406" Dia. Hole
Stamped And Engraved
"ISOLATED GROUND"



COLOR	STANDARD	MIDWAY	OVERSIZE	STANDARD	MIDWAY	MATERIAL	STANDARD	OVERSIZE
Orange	_____	_____	_____	80704-IG	_____	302 S/S	*	_____

*Consult The End Of This Wallplate Section For Ordering Details: Allow 3-4 Weeks For Delivery.

ENGRAVED WALLPLATES

Residential and Commercial Grade Wallplates

Hot Stamped and Engraved Plates

Thermoset (Plastic)	Thermoplastic (Nylon)	Assorted Metals (Engraved)
----------------------------	------------------------------	-----------------------------------

DESCRIPTION

1-Gang 1-Single, 1.60" Dia. Hole
Stamped And Engraved "ISOLATED GROUND"
For Use With 20A & 30A Single Locking
Receptacles



COLOR	STANDARD	MIDWAY	OVERSIZE	STANDARD	MIDWAY	MATERIAL	STANDARD	OVERSIZE
Orange	_____	_____	_____	80720-IG	_____	302 S/S	*	_____

1-Gang 1-Toggle
Stamped And Engraved
"EMERGENCY"



COLOR	STANDARD	MIDWAY	OVERSIZE	STANDARD	MIDWAY	MATERIAL	STANDARD	OVERSIZE
Red	_____	_____	_____	80701-RE	_____	302 S/S	84001-E40	_____

1-Gang 1-Duplex
Stamped
"GFCI PROTECTED"



COLOR	STANDARD	MIDWAY	OVERSIZE	STANDARD	MIDWAY	MATERIAL	STANDARD	OVERSIZE
Ivory	_____	_____	_____	80703-GFI	_____	302 S/S	*	_____
White	_____	_____	_____	80703-GRW	_____	302 S/S	*	_____

1-Gang 1-Duplex
Stamped
"COMPUTER ONLY"



COLOR	STANDARD	MIDWAY	OVERSIZE	STANDARD	MIDWAY	MATERIAL	STANDARD	OVERSIZE
Ivory	_____	_____	_____	80703-COI	_____	302 S/S	*	_____
White	_____	_____	_____	80703-COW	_____	302 S/S	*	_____

1-Gang 1-Decora
Stamped
"SURGE PROTECTED"



COLOR	STANDARD	MIDWAY	OVERSIZE	STANDARD	MIDWAY	MATERIAL	STANDARD	OVERSIZE
_____	_____	_____	_____	*	_____	302 S/S	*	_____

1-Gang 1-Decora
Stamped
"ISOLATED GROUND"



COLOR	STANDARD	MIDWAY	OVERSIZE	STANDARD	MIDWAY	MATERIAL	STANDARD	OVERSIZE
Orange	_____	_____	_____	80401-IG	_____	302 S/S	*	_____

1-Gang 1-Decora
Stamped
"GFCI"



COLOR	STANDARD	MIDWAY	OVERSIZE	STANDARD	MIDWAY	MATERIAL	STANDARD	OVERSIZE
Ivory	_____	_____	_____	80401-GFI	_____	302 S/S	*	_____
White	_____	_____	_____	80401-GFW	_____	302 S/S	*	_____

1-Gang 1-Decora
Stamped
"COMPUTER ONLY"



COLOR	STANDARD	MIDWAY	OVERSIZE	STANDARD	MIDWAY	MATERIAL	STANDARD	OVERSIZE
Ivory	_____	_____	_____	80401-COI	_____	302 S/S	*	_____
White	_____	_____	_____	80401-COW	_____	302 S/S	*	_____

*Consult The End Of This Wallplate Section For Ordering Details: Allow 3-4 Weeks For Delivery.

WALLPLATES Commercial Grade

Voice/Data/CATV Wallplates

These sturdy, high-impact wallplates for the 46000 series voice/data devices are available for single-gang applications with standard or Decora-compatible styling.



Standard Size Voice/Data/Catv Wallplates*

DESCRIPTION		COLOR (NYLON)	METAL	CAT. NO.
1-Gang Type "F" Connector		Ivory	—	80781-I
		White	—	80781-W
		Almond	—	80781-A
		Light Almond	—	80781-T
1-Gang Duplex Type "F" Connector		Ivory	—	80782-I
		White	—	80782-W
		Almond	—	80782-A
		Light Almond	—	80782-T
1-Gang* Db9 Data Connector Db15 Data Connector		—	302 S/S	84441-40
		—	302 S/S	84442-40
1-Gang* Bnc/Tnc "D" Connector		—	302 S/S	84444-40

WEATHER-RESISTANT COVERS

Commercial Grade

Features and Benefits

Plastic

- Impact resistant thermoplastic construction
- Pre-installed gasket for easy, reliable installation
- Tongue and groove plate-to-cover construction
- Offset device opening (horizontal only) for easier cord exit
- Thermoplastic inserts prevent insect and debris accumulation

Plastic and Metal

- Self-closing
- Vertical and horizontal mounting
- Die cast aluminum or impact-resistant thermoplastic covers and bases
- Weather-resistant gaskets
- Stainless steel springs
- Gray or clear finish



Raintight While-In-Use Covers

DESCRIPTION	MOUNTING	CAT. NO.
Duplex Receptacle, Gray, Standard	Vertical	5976-GY
Duplex Receptacle, Gray, Extra Deep	Vertical	5976-DGY
Duplex Receptacle, Clear, Standard	Vertical	5976-CL
Duplex Receptacle, Clear, Extra Deep	Vertical	5976-DCL
Decora/GFCI, Clear, Standard	Vertical	5977-CL
Decora/GFCI, Clear, Extra Deep	Vertical	5977-DCL
Single Receptacle, Gray, Standard	Vertical	5978-GY
Single Receptacle, Clear, Standard	Vertical	5978-CL
Single Receptacle, Gray, Extra Deep	Vertical	5978-DGY
Single Receptacle, Clear, Extra Deep	Vertical	5978-DCL
Duplex Receptacle, Gray, Standard	Horizontal	5996-GY
Duplex Receptacle, Gray, Extra Deep	Horizontal	5996-DGY
Duplex Receptacle, Clear, Standard	Horizontal	5996-CL
Decora/GFCI, Gray, Standard	Horizontal	5997-GY
Decora/GFCI, Gray, Extra Deep	Horizontal	5997-DGY
Decora/GFCI, Clear, Standard	Horizontal	5997-CL
Decora/GFCI, Clear, Extra Deep	Horizontal	5997-DCL
Single Receptacle, Gray, Standard	Horizontal	5998-GY
Single Receptacle, Gray, Extra Deep	Horizontal	5998-DGY
Single Receptacle, Clear, Standard	Horizontal	5998-CL

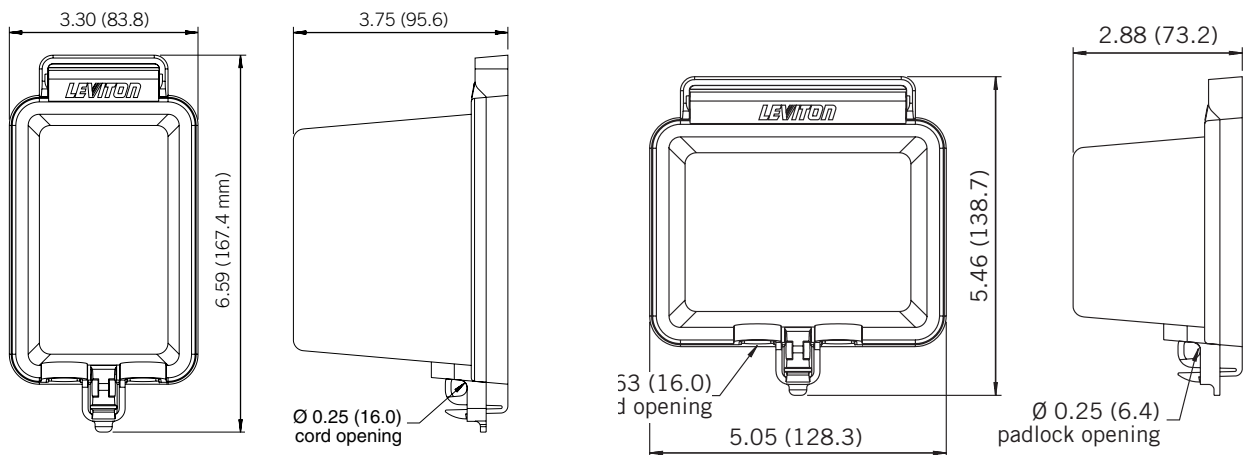

VERTICAL MOUNT, EXTRA DEEP
5976-D

HORIZONTAL MOUNT, STANDARD
5997

SPECIFICATIONS & FEATURES

- Mounting Screws and rubber gasket included for fast, easy installation onto surface-mounted outdoor-type boxes or flush-mounted wall boxes
- Easy-grip self-closing covers with durable, non-corrosive stainless steel screws
- backed by a Limited Two-Year Warranty

TESTING AND CODE COMPLIANCE

- Full compliance with UL, CSA and NEC Section 410-57 requirements for damp and wet locations with cover closed
- Raintight while-in-use covers are NEMA 3R rated for use with unattended plugs engaged in "live" receptacles in wet or damp locations

WEATHER-RESISTANT COVERS

Industrial Grade

Features and Benefits

- Glass-filled thermoplastic cover and plate for outstanding impact resistance and durability
- UL 94-VO Flammability Rating
- Superior IP 54 Suitability rating protects against dust particles and splashing water
- NEMA Type 3R enclosure rating ensures protection against rain, sleet and damage from external ice formation
- Dual gaskets, one under plate and one under lid, for weather-resistant fit
- Stainless steel hinge-pin, spring and mounting screws for excellent corrosion resistance
- Triple-combination screws accept Phillips, straight-blade or Robertson-head screwdrivers
- Oversized cover tab for easier opening with gloved hands
- Mounts to panel or FS/FD boxes
- UL Listed and CSA certified for wet locations with cover closed



Industrial Weather-Resistant Covers

DESCRIPTION	COLOR	CAT. NO.
For use with 15-amp locking, 15-amp and 20-amp straight-blade flanged inlets and outlets	GRAY	WP1
For use with 20-amp and 30-amp 3-, 4-, and 5-wire locking flanged inlets and outlets; 30-amp and 50-amp 3-wire power receptacles	GRAY	WP2
For use with 20-amp and 30-amp and FS/FD boxes single locking receptacles	YELLOW	7420-CR

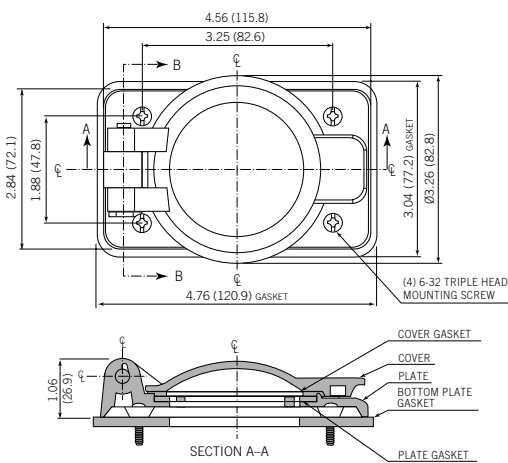

**WATER RESISTANT COVER
WP1 and 7420-CR**

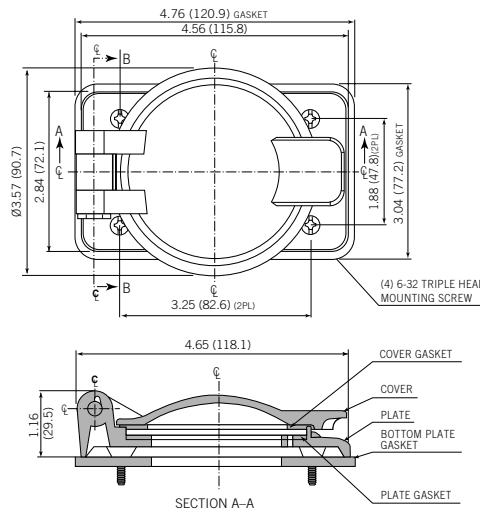

**WATER RESISTANT COVER
WP2**

TESTING AND CODE COMPLIANCE

- UL Listed (File # E-13397)
- CSA Certified (File # LR-16347)
- NOM Certified (# 057)
- IP 54 Suitability rating (protected against dust and splashing water)
- NEMA Type 3R enclosure rating
- Backed by a Limited 10-Year Warranty





MATERIAL CHARACTERISTICS

Environmental: VO Flammability Rating per UL 94
 Operating Temperature: -40°C to 75°C

WEATHER-RESISTANT COVERS

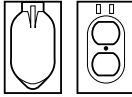
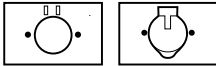
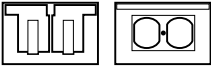
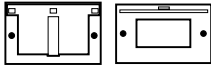
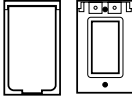
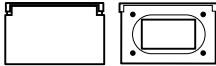
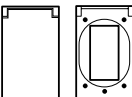
Industrial Grade

Die-Cast Zinc Weather-Resistant Covers

DESCRIPTION		MOUNTING	CAT. NO.
Duplex Receptacle 1-GANG		Vertical	4926
Single Receptacle 1-GANG Self-Closing Lid		Horizontal	4925-2
Duplex Receptacle or Combination Device 1-GANG Two Independent Self-Closing Lids [Ⓜ]		Horizontal	4970
Decora/GFCI 1-GANG Self-Closing Lid		Horizontal	4990
Decora/GFCI 1-GANG Self-Closing Lid [Ⓜ]		Vertical	4992
Decora/GFCI 1-GANG Self-Closing Lid for mounting on FS type box		Horizontal	6196-FS
Decora/GFCI 1-GANG Self-Closing Lid for mounting on FS type box		Vertical	6196-VFS
Weatherproof Wallplate & Switch 15A 120V AC		Horizontal or Vertical	1432
NEMA 1 Steel Enclosure without Switch		Vertical	N13NC
DESCRIPTION		COLOR	CAT. NO.
Lockout Wallplate (lock sold separately)		S/S	84001-LOK

All devices are UL Listed . Also CSA Certified except where indicated by[Ⓜ]

WEATHER-RESISTANT COVERS

Commercial Grade

Thermoplastic Weather-Resistant Covers

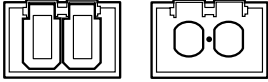
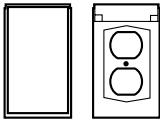
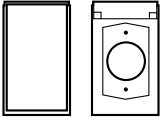
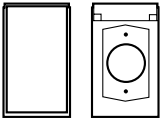
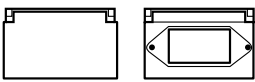
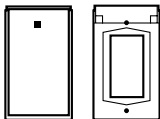
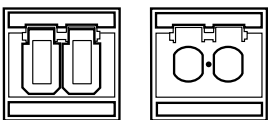
DESCRIPTION		MOUNTING	CAT. NO.
Duplex Receptacle or Combination Device 1-GANG Two Independent Self-Closing Lids		Horizontal	4976-GY 4976-W
Duplex Receptacle or Combination Device 1-GANG Self-Closing Lid		Vertical	4978-GY 4978-W
Single Receptacle 1-GANG Self-Closing Lid		Vertical	4979-GY
Single 20A or 30A Locking Receptacle 1-GANG Self-Closing Lid		Vertical	4980-GY
Decora/GFCI 1-GANG Self-Closing Lid		Horizontal	4996-GY 4996-W
Decora/GFCI 1-GANG Self-Closing Lid		Vertical	4998-GY 4998-W
Oversized Duplex 1-GANG Two Independent Self-Closing Lids		Horizontal	4986-GY

Blank Box Mounted Wallplates with Gasket

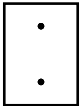
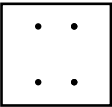
DESCRIPTION		MOUNTING	CAT. NO.
1-GANG Aluminum, Box Mount		N/A	83014-EXT
2-GANG Aluminum, Box Mount		N/A	83025-EXT

Type 302 Stainless Steel Wallplate—Box Mount

DESCRIPTION		COLOR	CAT. NO.
Type 302 Stainless Steel Wallplate w/Tamper-Resistant Screws and Spanner Tool		S/S	84071-40

All devices are UL Listed and CSA Certified.

WALLPLATE ACCESSORIES

Commercial Grade

Wallplate Screws

DESCRIPTION	COLOR	CAT. NO.
Oval Head Milled Slot 5/16" long—6-32 thread 100 per box	Ivory Gray White Brown Almond S/S	86400-PRT 87400-PRT 88400-PRT 85400-PRT 82400-PRT 84400-PRT
Oval Head Milled Slot 1/2" long—6-32 thread 100 per box	Ivory Black Gray White Brown S/S	86000-PRT 83000-PRT 87000-PRT 88000-PRT 85000-PRT 84000-PRT
Oval Head Milled Slot 7/8" long—6-32 thread 50 per box	Ivory Red White Brown S/S	86500-PRT 89500-PRT 88500-PRT 85500-PRT 84500-PRT

Pilot Light Jewels

DESCRIPTION	COLOR	CAT. NO.
Round Fits single receptacle hole 1.375-1.406" dia.	Green Red	405 GR 405 R
Rectangular Fits toggle switch hole .406 x .942"	Green Red	406 GR 406 R
Lampholder Assembly for use with jewels or louvre plates—use with standard 2.5" box and 4 watt bulb (bulb included)		2152

Mounting Screws

DESCRIPTION	COLOR	CAT. NO.
Phillips/Standard 7/8" long—6-32 thread 50 per bag	S/S	84440

Decora Plus Standard Size Plastic Adapters

DESCRIPTION	COLOR	CAT. NO.
CATV Jack	Ivory Black Gray White Almond Light Almond	80381-I 80381-E 80381-GY 80381-W 80381-A 80381-T
Blank No Hole	Ivory Black Gray White Almond Light Almond	80314-I 80314-E 80314-GY 80314-W 80314-A 80314-T

All devices are UL Listed and CSA Certified.

Tamper-Resistant Spanner Head Screws

DESCRIPTION	COLOR	CAT. NO.
Spanner Head 1/2" long—6-32 thread, 100 per box	S/S	84000-T
Screwdriver for Spanner head or Tamper-Resistant screws	Black	84000-TSD

Plastic Wallplate Adapters

DESCRIPTION	COLOR	CAT. NO.
These adapters permit the use of rotary dimmers in multi-gang Decora installations or fill blank holes in multi-device Decora or toggle wallplates.		
Dimmer Shaft .406" dia. Hole	Ivory Black Gray Brown White Almond Light Almond	80400-I 80400-E 80400-GY 80400 80400-W 80400-A 80400-T
Blank Decora No Hole	Ivory Black Gray Brown White Almond Light Almond	80414-I 80414-E 80414-GY 80414 80414-W 80414-A 80414-T
Blank Toggle No Hole	Ivory Gray Brown White	80700-I 80700-GY 80700 80700-W
Wallbox Adapter Extends shallow wallbox to fit GFCL/Decora devices	Ivory Brown White	6197-I 6197 6197-W

Snap in Grommet reduces 1.406" to 1.00" for use with single receptacle wallplates	Black	403-E
--	-------	-------

Thermoplastic Yoke/Mounting Strap w/screws Custom wallplate configurations 11, 23, 27 and 31 are supplied with strap kits.		404
--	--	-----

Special Wallplates

The Order Form and instructions requesting custom wallplate configurations are found on the following pages. Custom wallplates are available in a variety of metals and can be requested through special order, beginning on the next page.

All devices are UL Listed and CSA Certified.

WALLPLATES

How to Order Custom Wallplates



General Information

Custom wallplates, up to twelve gangs in size, made of brass, stainless steel, painted steel, aluminum or chrome, can be special ordered. Any combination of the configurations shown can be specified to meet your needs. In addition, standard and custom metal wallplates can be engraved, and standard nylon wallplates can be hot stamped, with the message of your choice. Follow the steps below to fill out the Custom Wallplate Order Form completely and accurately. The finished order form must include:

1. The wallplate catalog number
2. The type of wallplate material desired (from the Material Code Chart)
3. The quantity of wallplates desired
4. The wallplate configurations in proper order (from the Configuration Code Chart)
5. The wallplate color, selected from the Wallplate Color Code Chart
6. Engraved or hot stamped message, if desired, with message location and letter size
7. Engraved or hot stamped message filler color, selected from the Fill-In Color Chart

Photocopy the blank Custom Wallplate Order Form at the back of this section and refer to the completed sample Custom Wallplate Order Form shown when filling out your order. Your representative can provide you with additional forms if needed. The sample order grid below shows the custom wallplate pictured at right:

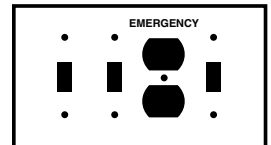

Sample Grid

CAT. NO. 90004 MATERIAL CODE S3 QTY. 1

(1) (2) (3) (4) (5) (6) (7) (8) (9) (10) (11) (12)

01	01	EMERGENCY 03	01	□	□	□	□	□	□	□	□
----	----	-----------------	----	---	---	---	---	---	---	---	---

COLOR CODE _____ ENGRAVED HOT STAMPED _____ LETTER SIZE 3/8"

FILLER CODE XR PRICE _____

WALLPLATES

How to Order Custom Wallplates

How to Fill Out the Custom Wallplate Order Form

STEP 1: DETERMINE THE WALLPLATE CATALOG NUMBER

The catalog number for a custom wallplate is determined as follows: a single-gang custom wallplate is Cat. No. 90001, a double-gang custom wallplate is Cat.No. 90002, a three-gang custom wallplate is Cat. No. 90003, and so on through the sequence to Cat. No. 90010 for the ten-gang custom wallplate. Enter the number in the space on the Order Form marked "CAT. NO." If you are ordering a standard metal wallplate for custom engraving, use the 90000 series number. If you are ordering a standard nylon wallplate for custom hot stamping, enter that wallplate's catalog number in the space on the Order Form marked "CAT. NO."

STEP 2: SELECT THE WALLPLATE MATERIAL

Choose the custom wallplate material desired from the Wallplate Material Chart below. Enter the Material Code for the material selected in the space marked "MATERIAL CODE" on the Order Form. When ordering Custom Hot Stamped wallplates, enter NYLON.

MATERIAL	MATERIAL CODE
Aluminum [†]	AL
Brass (Satin)	BR
Polished Brass	PB
Non-Magnetic Stainless Steel-Type 302/304	S3
Oversize Non-Magnetic Stainless Steel-Type 302/304*	S30
Painted Steel	S5
Oversize Painted Steel*	S50
Chrome	CRM
Raw Steel	RAW

[†]6-Gang maximum size, standard size only























*4-Gang maximum size

STEP 3: DETERMINE THE QUANTITY OF THE WALLPLATE ORDER

Enter the quantity of wallplates needed in the space marked "QUANTITY" on the Order Form.

STEP 4: DETERMINE THE CUSTOM WALLPLATE CONFIGURATION

The Wallplate Configuration Chart below shows all the configurations that can be specified for custom metal wallplates. Each configuration has a specific Configuration Code number in the lower right-hand corner of its corresponding space on the chart. Enter this configuration code in the center of the corresponding square on the Order Form Grid to match its desired position on the finished custom wallplate. Refer to the Sample Order Form Grid for clarification on configurations and their placement, if necessary.

 Toggle Switch 01	 Duplex Receptacle 03	 Louvre Horizontal Mount 05	 Louvre Vertical Mount** 07	 Blank Box Mount 09	 Blank Strap Mount 11
 Decora/ GFCI 13	 Single 1.406" dia. Receptacle 15	 1.60" dia. Hole 17	 2.15" dia. Hole** 19	 2.647" dia. Hole** 21	 .312" dia. Hole Strap Mount 23
 .312" dia. Hole Box Mount 25	 .406" dia. Hole Strap Mount 27	 .406" dia. Hole Box Mount 29	 .625" dia. Hole Strap Mount 31	 .625" dia. Hole Box Mount 33	 Interchangeable 1-Device Vertical 35
 Interchangeable 1-Device Horizontal 37	 Interchangeable 2-Device 39	 Interchangeable 3-Device 41	 2.460" dia. Hole 2-Gang Only** 47	0.880" dia. Hole for Key Lock Power Switch**. Tamper-resistant screws and screwdriver included w/Key Lock configurations. Device mount unless specified otherwise. For 1-gang, order 84071-40.	
				 49	

Enter the code number for the configurations you select in the center box on each desired wallplate position on the Custom Wallplate Order Form.

*3-Gang minimum

**2-Gang minimum

WALLPLATES

How to Order Custom Wallplates

How to Fill Out the Custom Wallplate Order Form (continued)

STEP 5: SELECT THE WALLPLATE COLOR

For painted metal, select one of the following colors and enter its color code in the space marked "COLOR CODE" on the order form:

COLOR	WALLPLATE COLOR CODE
Almond	PA
Black	PE
Brown	PB
Gray	PG
Ivory	PI
Orange	PO
Red	PR
White	PW

STEP 6: ENTER ENGRAVING INFORMATION

NOTE: WE CAN ENGRAVE NYLON AND PAINTED AND UNPAINTED METAL WALLPLATES. After completing steps 1-5:

6A) Type or clearly print the message(s) (i.e., TURN OFF) as you wish it to appear on the lines provided in the appropriate Grid box(es). **6B)** Select the size of the letters you desire for the wallplate message from the dimensions shown below and enter that size in the space marked "LETTER SIZE" on the Order Form. **6C)** Select the fill-in color for the message letter from the chart below and enter the code for the color chosen in the space marked "FILLER CODE."

FILLER COLOR CODES for Engraved Wallplates

COLOR	CODE
Black	XE
White	XW
Red	XR
No Filler	XX

LETTER SIZE GAUGE for Engraved Wallplates

1/8"	3/16"	1/4"	5/16"	3/8"
E	E	E	E	E

STEP 7: ENTER HOT STAMPING INFORMATION

7A) Select the message(s) desired from the Message Library below. Enter the message on the lines provided in the appropriate Grid box(es) where they should appear. The message will be stamped in 3/16"-high text.

HOT STAMPING MESSAGE LIBRARY FOR CUSTOM NYLON WALLPLATES

1. SHOWER	7. HEAT	13. ON	19. ISOLATED	25. EQUIP
2. VANITY	8. DATA	14. PROTECTED	20. GROUND	26. FLUORESCENT
3. VOICE	9. COMPUTER	15. OFF	21. CONDITIONED	27. OIL
4. ONLY	10. GFCI	16. OIL BURNER	22. CONDITIONED POWER	28. POWER
5. ISOLATED GROUND	11. SURGE	17. PC	23. CRITICAL	29. UPS
6. EMERGENCY	12. FAN	18. DEDICATED	24. ELEC.	

7B) Select the fill-in color for the message letter from the chart below and enter the code for the color chosen in the space marked "FILLER CODE."

COLOR	CODE
Black	XE
White	XW
Red	XR
No Filler	XX

To order nylon wallplates with custom hot stamped message, contact our salesman or customer service representative.

8) NOTE: Sequential engraving is available. Consult factory for ordering instructions.

WALLPLATES

How to Order Custom Wallplates

Custom Wallplate Order Form

BILL TO:

SHIP TO:

CAT. NO. _____ MATERIAL CODE _____ QTY. _____

(1) (2) (3) (4) (5) (6) (7) (8) (9) (10) (11) (12)

<input type="checkbox"/>	<input type="checkbox"/>	<input type="checkbox"/>	<input type="checkbox"/>	<input type="checkbox"/>	<input type="checkbox"/>	<input type="checkbox"/>	<input type="checkbox"/>	<input type="checkbox"/>	<input type="checkbox"/>	<input type="checkbox"/>	<input type="checkbox"/>	<input type="checkbox"/>
--------------------------	--------------------------	--------------------------	--------------------------	--------------------------	--------------------------	--------------------------	--------------------------	--------------------------	--------------------------	--------------------------	--------------------------	--------------------------

COLOR CODE _____ ENGRAVED _____ HOT STAMPED _____ LETTER SIZE _____

FILLER CODE _____ PRICE _____

ENGRAVING INFORMATION (Please print per corresponding gang number.)

(1)

(2)

(3)

(4)

(5)

(6)

(7)

(8)

(9)

(10)

(11)

(12)

DESCRIPTION
 (Use this space to add additional information that may be helpful.)

TERMS

- Please take care to complete your order carefully. Custom wallplates cannot be returned
- Custom orders are shipped in three to four weeks
- All engraving shall be centered within its corresponding gang unless specifically instructed to span across multiple gangs
- All engravings on toggle configurations shall appear above the mounting screw holes unless specifically instructed otherwise
- All engravings on GFCI/Decora configurations shall appear below the mounting screw hole unless specifically instructed otherwise