

Snap-N-Service









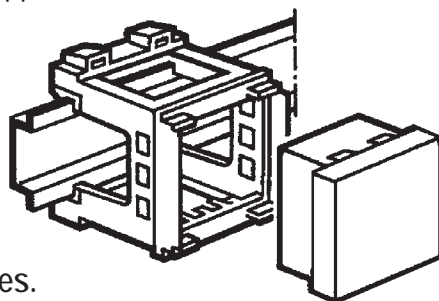











Put a Service Outlet to Your Cabinet...

Features:

- Multi standard range unlimited possibilities.
- Various international outlets available.
- DIN-Rail support frame available.
- Used to put a service outlet to cabinets or any other equipment.
- Saves installation time and additional stocking charges.
- Metallclad surface boxes permits the mounting of modules directly.
- Snap-In modules provides various applications.
- International certifications where applicable.

Modules available for:
 Argentina, Australia, Belgium,
 Canada, China, Denmark,
 France, Germany, Israel,
 Italy, Poland, Switzerland,
 United Kingdom, U.S.A.
 Combination Units & Accessories.



Document	Catalog No. / Katalog-Nr.	Description / Beschreibung	Weight/ea	VPE/Pack	U/M	EDP-No.
2314	Continental Europe Snap-In Modul Mechanisms, (45x45)mm or (22.5x45)mm					
	74140 (GB)	British Standard, BS 1363, 250Vac, 13A, 2P+E, White	38 g	100/10	ea	112912
	74130 (D)	Germany (SCHUKO), Shuttered, 250Vac, 16A, 2P+E, White	37 g	200/10	ea	115407
	74133 (D)	Germany (SCHUKO), with Closing Lid, 250Vac, 16A, 2P+E, White	39 g	100/10	ea	117578
	74105 (I)	Italy, Shuttered for Child Safety, 250Vac, 10A, 2P+E, White	26 g	100/10	ea	116102
	74106 (I)	Italy, Shuttered for Child Safety, 250Vac, 10/16A, 2P+E, White	26 g	100/10	ea	112916
	74169 (CH)	Switzerland Typ 13, Shuttered, 250Vac, 10A, 2P+E, White	25 g	100/10	ea	112910
	74111 (F)(B)	France/Belgium/Poland, with Shutters, 250Vac, 10/16A, 2P+E, White	36 g	200/10	ea	112908
	74112 (F)(B)	France/Belgium/Poland, w/Neon/Shutters, 250Vac, 10/16A, 2P+E, White	41 g	100/10	ea	114686
	74116 (F)(B)	France/Belgium/Poland, w/Lid/Shutters, 250Vac, 10/16A, 2P+E, White	43 g	100/10	ea	114172
2317	North America, Japan, South America Snap-In Modul Mechanisms, (45x45)mm or (22.5x45)mm					
	74180 (USA)(CDN)	USA/Canada/Japan, NEMA 5-15R, 127Vac, 15 Amp., 2P+E, White	39 g	100/10	ea	112909
	74101 (US/EU) 2P	USA/Brazil/Europe, 127/250Vac, 15/16A, 2P Non-Grounding, White	23 g	100/10	ea	116100
	74102 (US/EU)	USA/South America/Europe, 127/250Vac, 15/16A, 2P+E, White	42 g	100/10	ea	117716
2316 2349 2310	Various Snap-In Modul Mechanisms, (45x45)mm					
	74167 (AUS)	Australia, 250Vac, 10A, 2P+E, White	33 g	100/10	ea	112913
	19472 (DK)	Denmark, 250Vac, 13A, 2P+E, White	29 g	100/10	ea	119207
	19465 (DK-DATA)	Denmark, EDB, 250Vac, 13A, 2P+E, White	27 g	100/10	ea	119208
	74152 (ROC)	China, with Shutters, 250Vac, 10A, 2P+E, White	36 g	100/10	ea	117717
	74153 (ROC)	China, with Shutters, 250Vac, 16A, 2P+E, White	45 g	100/10	ea	117718
	74174 (IL)	Israel, 250Vac, 16A, 2P+E, White	32 g	100/10	ea	117719
	74175 (IL)	Israel, dedicated, 250Vac, 16A, 2P+E, White	43 g	100/10	ea	117760
	74170 (ARG)	Argentina, 250Vac, 10A, 2P+E, White	34 g	100/10	ea	117720
	74171 (ARG)	Argentina, 250Vac, 20A, 2P+E, White	34 g	100/10	ea	117721

Cat.No. 74872

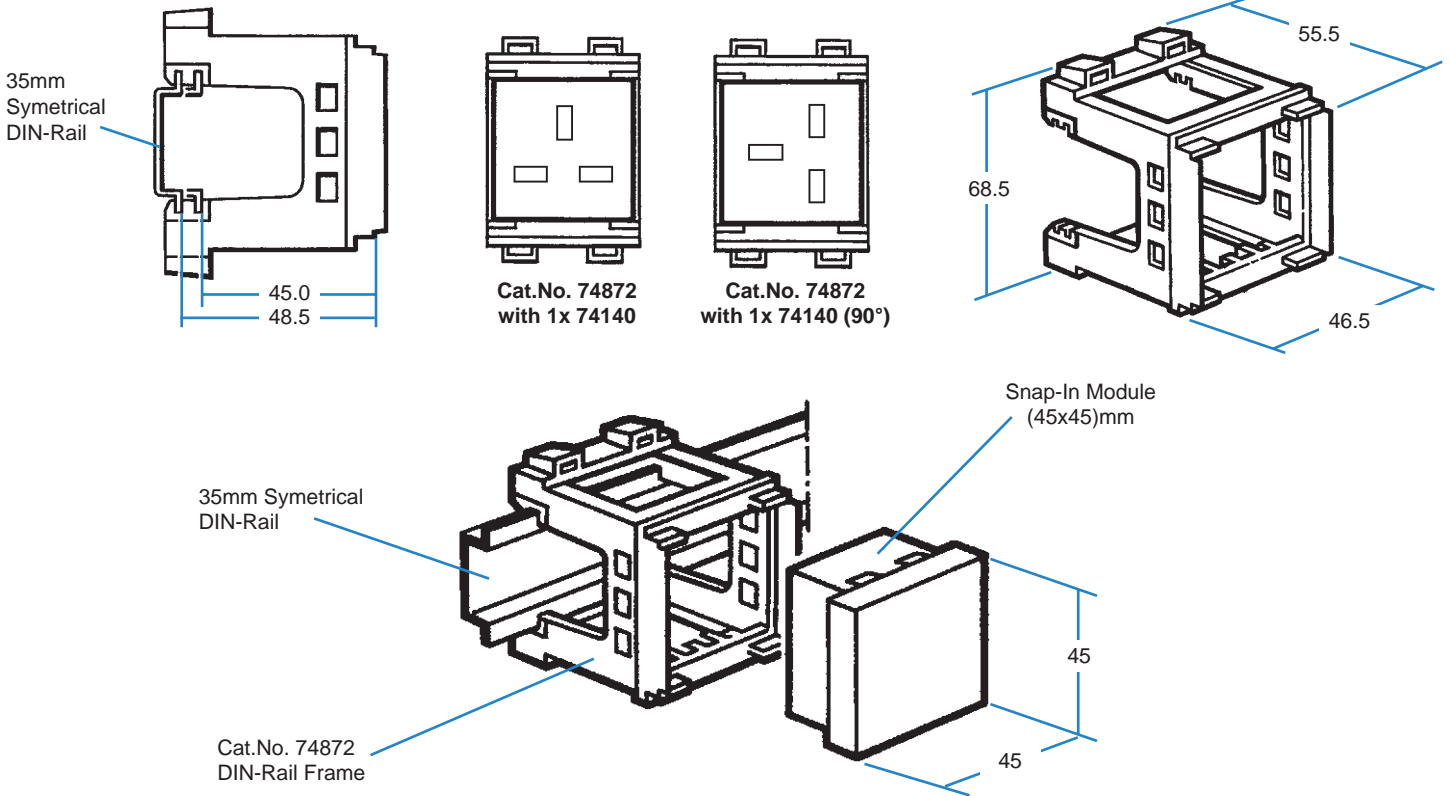

Document	Catalog No. / Katalog-Nr.	Description / Beschreibung	Weight/ea	VPE/Pack	U/M	EDP-No.
----------	---------------------------	----------------------------	-----------	----------	-----	---------

2314 2317 2319	Blanking Plate Snap-In Modul Mechanisms, (45x45)mm or (22.5x45)mm					
-------------------------------------	--	--	--	--	--	--



74391	Blanking Plate (22.5x45)mm, Plastic, White	5 g	100/10	ea	115976
74392	Blanking Plate (45x45)mm, Plastic, White	11 g	100/10	ea	117761

2223 2538	Surface Boxes for Snap-In Modul Mechanisms				
-------------------------	---	--	--	--	--

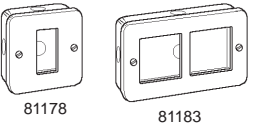

81178	Surface Metalclad Box (82x82x44)mm, ø 20mm conduit entries, All boxes includes grid with earth terminal. for Use with One (22.5x45)mm Module, Gray	224 g	50/5	ea	117772
81179	for Two (22.5x45)mm Modules, or One (45x45)mm Module, Gray	207 g	50/5	ea	117773
81183	Surface Metalclad Box (143x82x44)mm, Two (45x45) Module, Gray	316 g	25/5	ea	117774

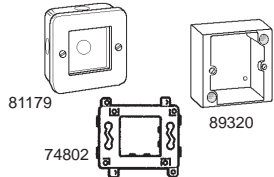

89314	Surface Plastic Box, White, Depth 30mm, (80x80)mm	34 g	100/5	ea	117875
89320	Surface Plastic Box, White, Depth 40mm, (80x80)mm	43 g	100/5	ea	117866
74802	Screw Mount Module Support Frame, Used w/Cat. # 89314 or 89320	27 g	400/20	ea	117867
75002	Plastic Cover Plate, White, (80x80)mm, Used with Cat.No. 74802	18 g	200/20	ea	117868

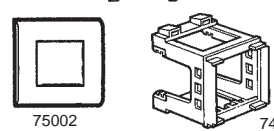

DIN-Rail Mounting Frame for Modular Devices					
74872	Snap-On Mounting Frame for Symmetrical 35mm DIN-Rail, Plastic, White, Support for Two (22.5x45)mm Modules, or One (45x45)mm Module, Dimensions: Width 46.5mm x 68.5mm x Height 55.5mm	17 g	200/10	ea	112911

Cat.No. 81179 with 1x 74180

Cat.No. 81183 with 2x 74180

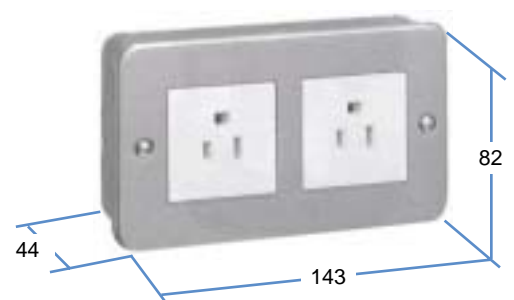
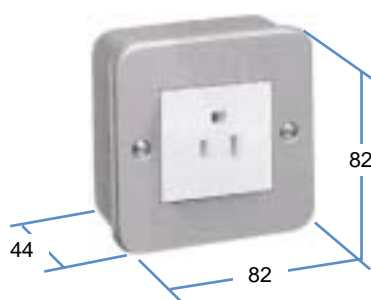

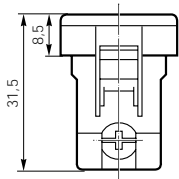

74101

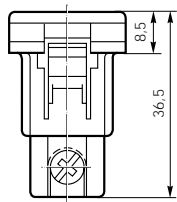

74105 + 74106

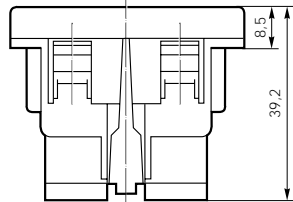

74130

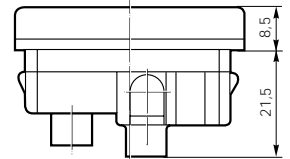

74140

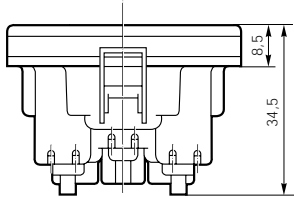

74169

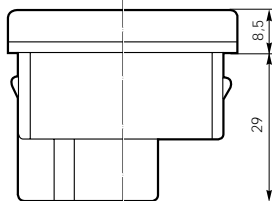

74167

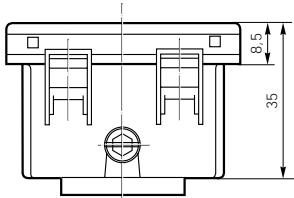

74180

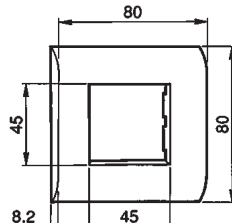

75002

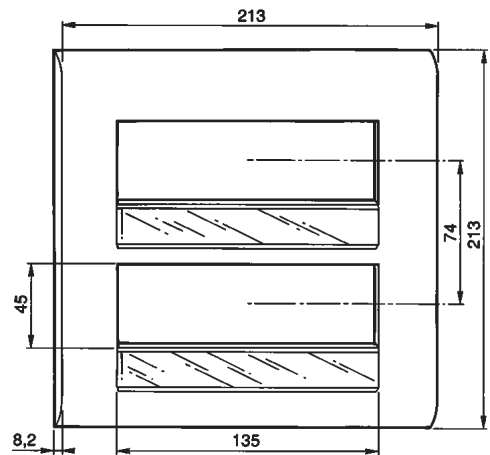

75042

Document	Catalog No. / Katalog-Nr.	Description / Beschreibung	Weight/ea	VPE/Pack	U/M	EDP-No.
----------	---------------------------	----------------------------	-----------	----------	-----	---------

117867 Modul Cover and Support Frame for 6 (45x45)mm or 12 (22.5x45)mm Modules

<p>74825</p>	74825	Metal Frame for 2 x 6 Modules, Horizontal Screw Mounting	266 g	25/5	ea	121200
	75042	Plastic Plate, White, for 2 x 6 Modules (22.5x45)mm, or 2 x 3 Modules (45x45)mm, Horizontal Mounting, Clipped on using slats for reduced thickness, With label holder Dimensions (213x213)mm	112 g	25/5	ea	121201

Further Frames and Cover Plates can be found in [Document #117867](#)

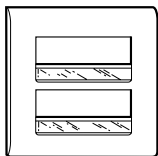

75042

To learn more about B-I-A please visit us at our
WEB site: www.BiaGmbH.com

